

JOHN TEMPLETON FOUNDATION

SUPPORTING SCIENCE ~ INVESTING IN THE BIG QUESTIONS

Projects: *A Quantum-Digital Universe*, Grant ID: 43796

Quantum Causal Structures, Grant ID: 60609



Causality Reloaded

G. M. D'Ariano

Università degli Studi di Pavia

HONG KONG WORKSHOP ON QUANTUM INFORMATION AND FOUNDATIONS
Focus on: The Role of The Observer

Department of Computer Science, The University of Hong Kong, 8th-12th January

Info-theoretical principles for Quantum Theory and Quantum Field Theory

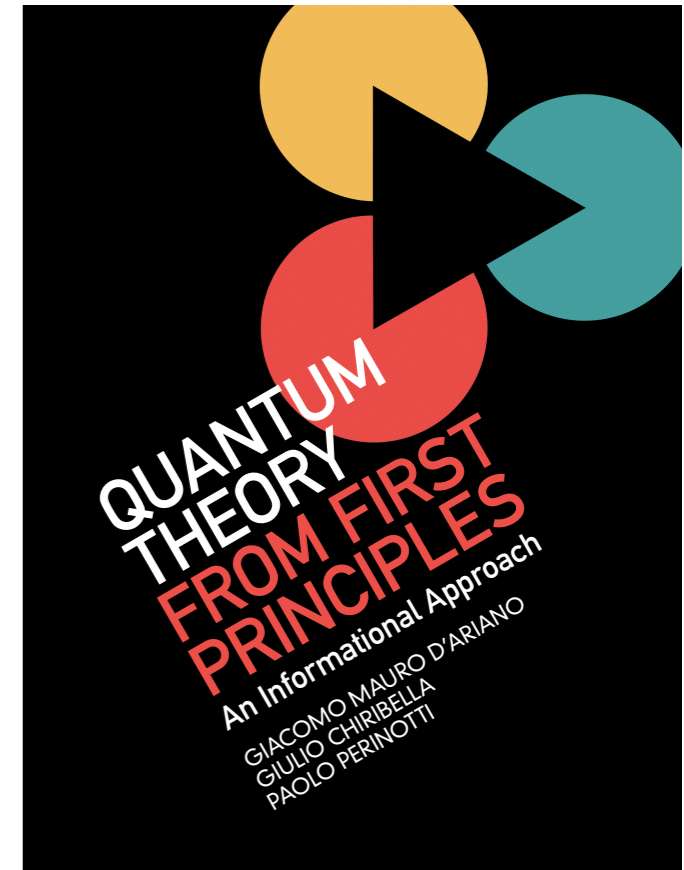
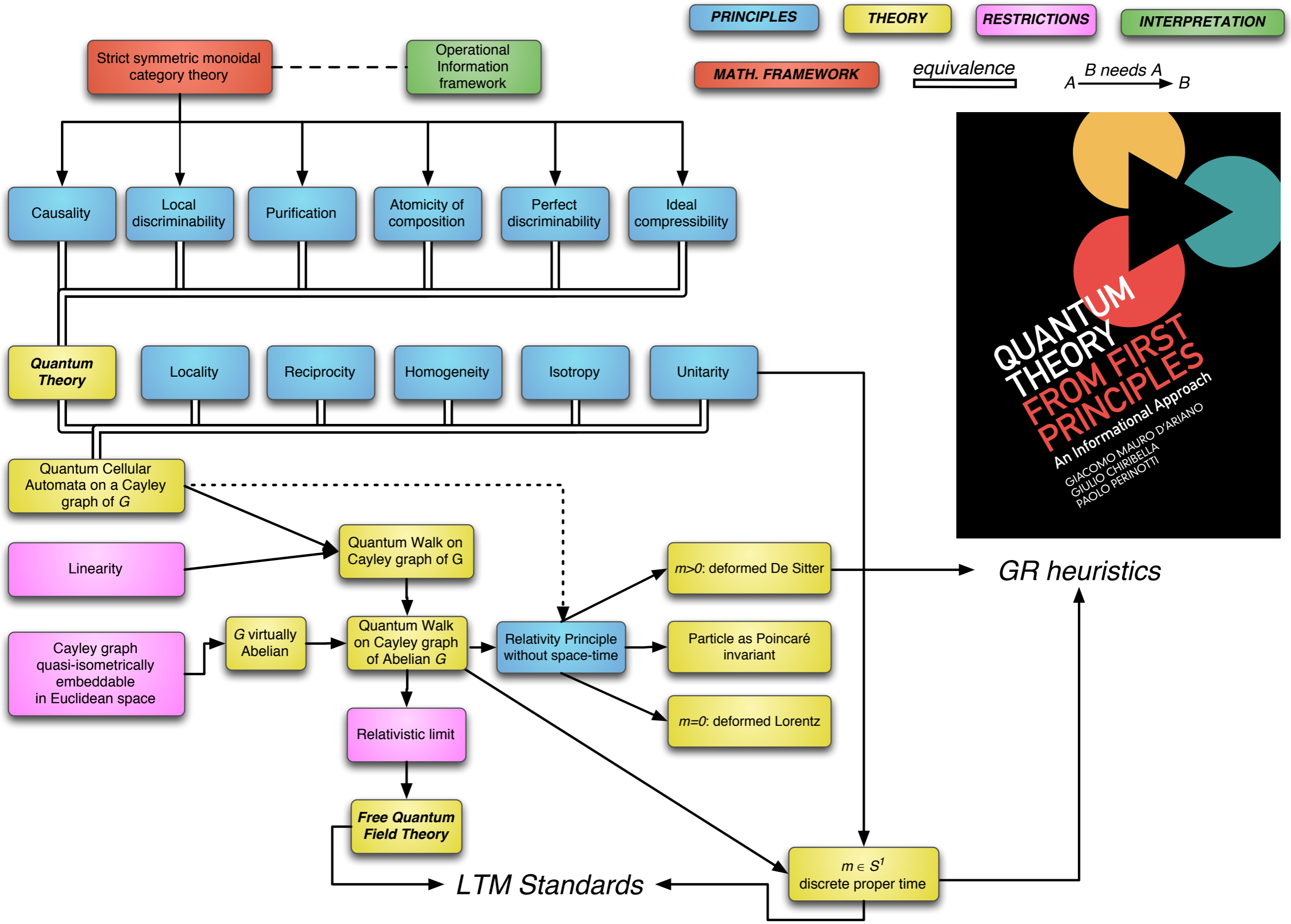

Cover design: Andrew Ward

"An extraordinary book on the deep principles behind quantum theory."
NICOLAS Gisin, UNIVERSITY OF GENEVA
"Part quantum mechanics textbook, part original research contribution, this book is a fascinating, audacious effort to 'rebuild quantum mechanics from the ground up,' presenting it as the logical consequence of simple information-theoretic postulates. Students wishing to learn quantum information should read it and do all the exercises!"
SCOTT AARONSON, MIT

Quantum theory is the soul of theoretical physics. It is not just a theory of specific physical systems, but rather a new framework with universal applicability. This book shows how we can reconstruct the theory from six information-theoretical principles, by rebuilding the quantum rules from the bottom up. Step by step, the reader will learn how to master the counterintuitive aspects of the quantum world, and how to efficiently reconstruct quantum information protocols from first principles. Using intuitive graphical notation to represent equations, and with shorter and more efficient derivations, the theory can be understood and assimilated with exceptional ease. Offering a radically new perspective on the field, the book contains an efficient course of quantum theory and quantum information for undergraduates. The book is aimed at researchers, professionals, students in physics, computer science and philosophy, as well as the curious outsider seeking a deeper understanding of the theory.

GIACOMO MAURO D'ARIANO is a Professor at Pavia University, where he teaches Quantum Mechanics and Foundations of Quantum Theory, and leads the group QUIT. He is a Fellow of the American Physical Society and of the Optical Society of America, a member of the Academy Istituto Lombardo di Scienze e Lettere, of the Center for Photonic Communication and Computing at Northwestern IL, and of the Foundational Questions Institute (FQXi).

GIULIO CHIRIBELLA is Associate Professor at the Department of Computer Science of The University of Hong Kong. He is a Visiting Fellow of Perimeter Institute for Theoretical Physics, a member of the Standing Committee of the International Colloquia for Theoretical Methods in Physics, and a member of the Foundational Questions Institute (FQXi). In 2010, he was awarded the Hermann Weyl Prize for applications of group theory in quantum information.

PAOLO PERINOTTI is Assistant Professor at Pavia University where he teaches Quantum Information Theory. His research activity is focused on foundations of quantum information, quantum mechanics and quantum field theory. He is a member of the Foundational Questions Institute (FQXi), and of the International Quantum Structures Association. In 2016 he was awarded the Birkhoff-von Neumann prize for research in quantum foundations.

D'ARIANO,
CHIRIBELLA
AND PERINOTTI



QUANTUM THEORY
FROM FIRST PRINCIPLES

QUANTUM THEORY

FROM FIRST PRINCIPLES

An Informational Approach

GIACOMO MAURO D'ARIANO
GIULIO CHIRIBELLA
PAOLO PERINOTTI

CAMBRIDGE
UNIVERSITY PRESS
www.cambridge.org



CAMBRIDGE

Info-theoretical principles for Quantum Theory and Quantum Field Theory

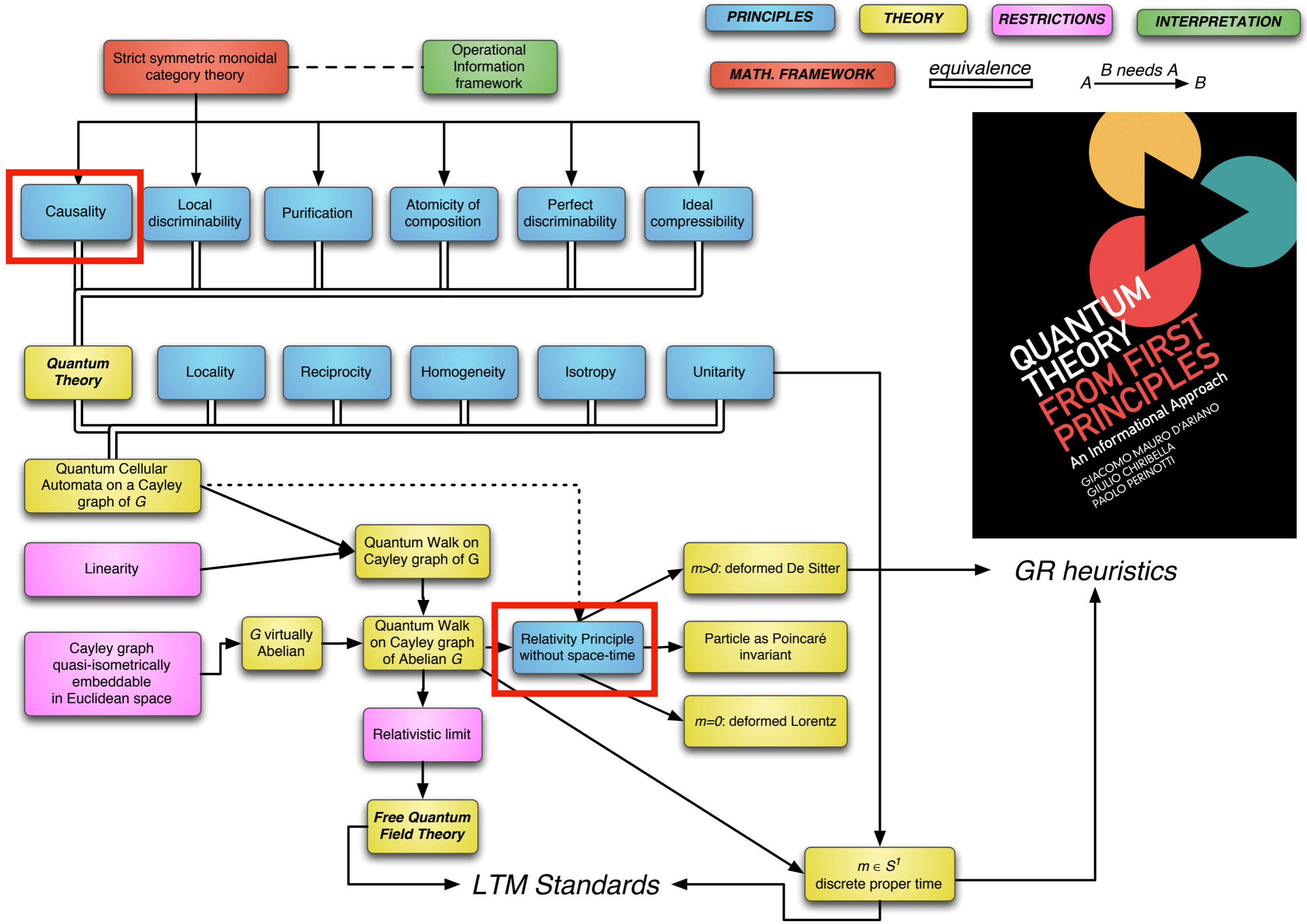

than we do its future. But we think we know more about where it came from than where it might be going. Ultimately, even if we don't realize it, the source of our confidence is the fact that entropy was lower in the past. We are very used to unbroken eggs breaking; that's the natural way of things. In principle, the set of things that could befall the egg in the future is precisely the same size as the set of ways it could have arrived in its present condition, as a consequence of conservation of information. But we use the Past Hypothesis to rule out most of those possibilities about the past.

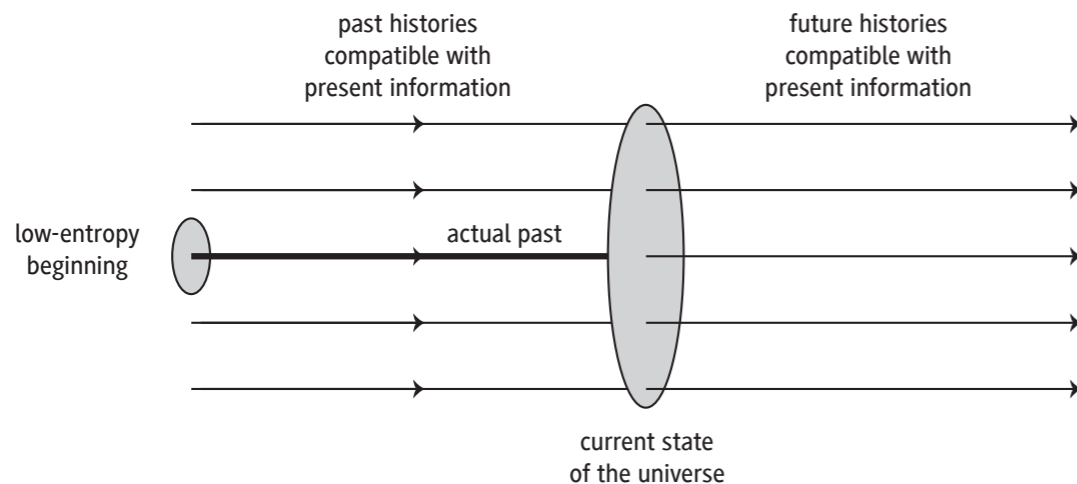

The Past Hypothesis of a low-entropy beginning breaks the symmetry between the past, on the left, and future, on the right.

The story of the egg is a paradigm for every kind of “memory” we might have. It’s not just literal memories in our brain; any records that we may have of past events, from photographs to history books, work on the same principle. All of these records, including the state of certain neuronal connections in our brain that we classify as a memory, are features of the current state of the universe. The current state, by itself, constrains the past and future equally. But the current state plus the hypothesis of a low-entropy past gives us enormous leverage over the actual history of the universe. It’s that leverage that lets us believe (often correctly) that our memories are reliable guides to what actually happened.

Back in chapter 4 we highlighted how Laplace’s conservation of information undermines the central role that Aristotle placed on causality.

Causality: the Cinderella of Physics



Concepts like “cause” appear nowhere in Newton’s equations, nor in our more modern formulations of the laws of nature. But we can’t deny that the idea of one event being caused by another is very natural, and seemingly a good fit to how we experience the world. This apparent mismatch can be traced back to entropy and the arrow of time.

It might seem strange to describe the world as operating according to unbreakable physical laws, and then turn around and deny causality a central role. After all, if the laws of physics predict what will happen at the next moment from what the situation is now, doesn’t that count as “cause and effect”? And if we don’t think that every effect has a cause, aren’t we unleashing chaos on the world, and saying that basically anything can happen?

The strangeness evaporates once we appreciate the substantial difference between the kind of relationship of the past to the future that we get from the laws of physics, and the kind we usually think of as cause and effect. The laws of physics take the form of rigid patterns: if the ball is at a certain position and has a certain velocity at a certain time, the laws will tell you what the position and velocity will be a moment later, and what they were a moment before.

When we think about cause and effect, by contrast, we single out certain events as uniquely *responsible* for events that come afterward, as “making them happen.” That’s not quite how the laws of physics work; events simply are arranged in a certain order, with no special responsibility attributed to one over any of the others. We can’t pick out one moment, or a particular aspect of any one moment, and identify it as “the cause.” Different moments in time in the history of the universe follow each other, according to some pattern, but no one moment causes any other.

•

Understanding this feature of how nature works has led some philosophers to advocate that we eliminate cause and effect entirely. As Bertrand Russell once memorably put it:

The law of causality, I believe, like much that passes muster among philosophers, is a relic of a bygone age, surviving, like the monarchy, only because it is erroneously supposed to do no harm.

Causality: the Cinderella of Physics

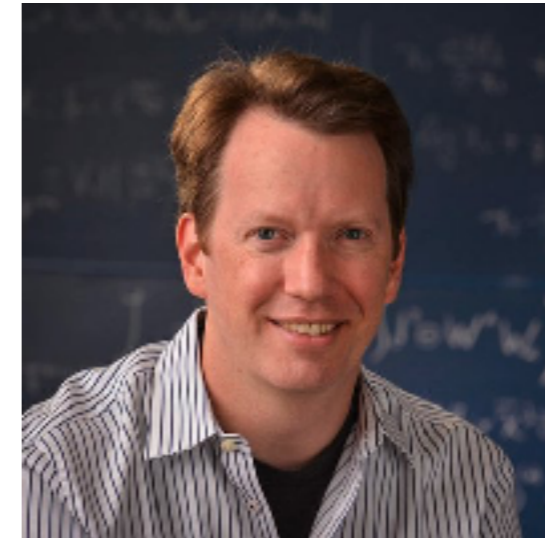

PAPERS READ BEFORE THE SOCIETY,
1912-1913.

I.—ON THE NOTION OF CAUSE.

By BERTRAND RUSSELL.

IN the following paper I wish, first, to maintain that the word "cause" is so inextricably bound up with misleading associations as to make its complete extrusion from the philosophical vocabulary desirable; secondly, to inquire what principle, if any, is employed in science in place of the supposed "law of causality" which philosophers imagine to be employed; thirdly, to exhibit certain confusions, especially in regard to teleology and determinism, which appear to me to be connected with erroneous notions as to causality.

All philosophers, of every school, imagine that causation is one of the fundamental axioms or postulates of science, yet, oddly enough, in advanced sciences such as gravitational astronomy, the word "cause" never occurs. Dr. James Ward, in his *Naturalism and Agnosticism*, makes this a ground of complaint against physics: the business of science, he apparently thinks, should be the discovery of causes, yet physics never even seeks them. To me it seems that philosophy ought not to assume such legislative functions, and that the reason why physics has ceased to look for causes is that, in fact, there are no such things. The law of causality, I believe, like much that passes muster among philosophers, is a relic of a bygone age, surviving, like the monarchy, only because it is erroneously supposed to do no harm.

Causality: the Cinderella of Physics

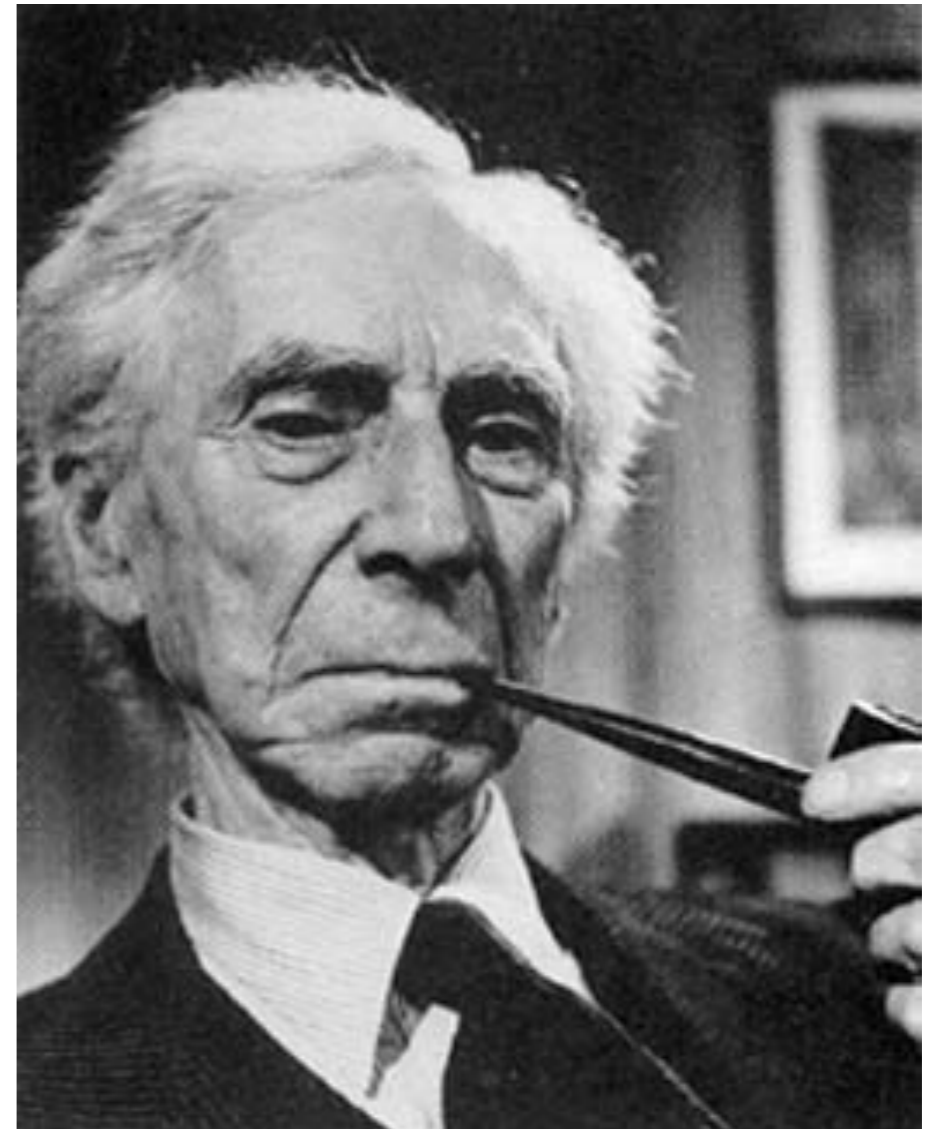

Causality: the Cinderella of Physics

The reason why there's a noticeable distinction between up and down for us isn't because of the nature of space; it's because we live in the vicinity of an extremely influential object: the Earth. Time works the same way. In our everyday world, time's arrow is unmistakable, and you would be forgiven for thinking that there is an intrinsic difference between past and future. In reality, both directions of time are created equal. The reason why there's a noticeable distinction between past and future isn't because of the nature of time; it's because we live in the aftermath of an extremely influential event: the Big Bang.

...

The thing we need to add is an assumption about the initial condition of the observable universe, namely, that it was in a very low-entropy state. Philosopher David Albert has dubbed this assumption the Past Hypothesis.

...

What we know is that this initially low entropy is responsible for the "thermodynamic" arrow of time,...

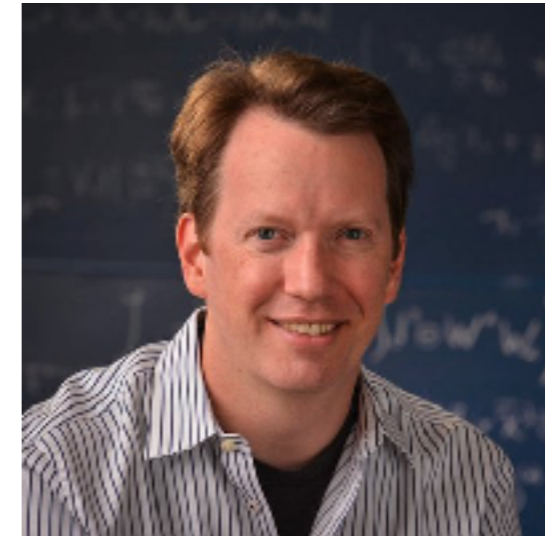

The Block Universe

BLOCK TIME

All Time Like the Present

According to conventional wisdom, the present moment has special significance. It is all that is real. As the clock ticks, the moment passes and another comes into existence—a process that we call the flow of time. The moon, for example, is located at only one position in its orbit around Earth. Over time it ceases to exist at that position and is instead found at a new position.

Researchers who think about such things, however, generally argue that we cannot single out a present moment as special when every moment considers itself to be special. Objectively, past, present and future must be equally real. All of eternity is laid out in a four-dimensional block composed of time and the three spatial dimensions. (This diagram shows only two of these spatial dimensions.)

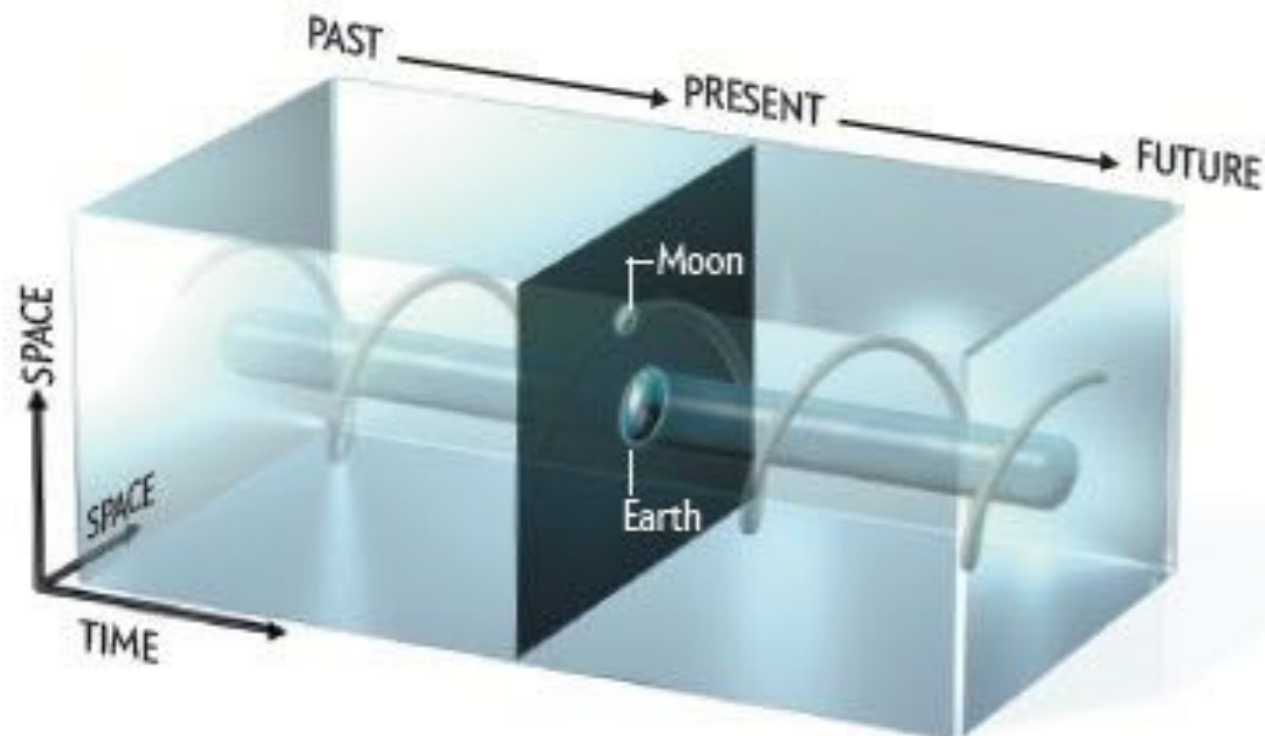

Conventional view: Only the present is real



Block universe: All times are equally real



Did we forget

...

Quantum Theory?

Principles for Quantum Theory

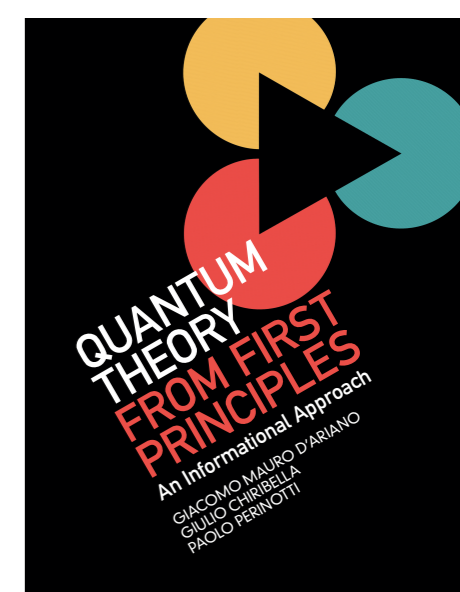

P1. **Causality**

P2. Local discriminability

P3. Purification

P4. Atomicity of composition

P5. Perfect distinguishability

P6. Lossless Compressibility

The probability of preparations is independent of the choice of observations

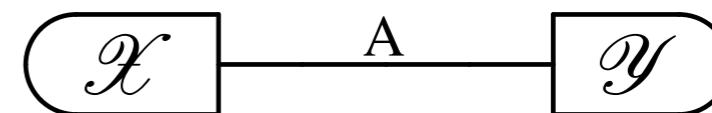

$$\sum_j p(i, j | \mathcal{X}, \mathcal{Y}) =: p(i | \mathcal{X}, \mathcal{Y})$$



$$p(i | \mathcal{X}, \mathcal{Y}) = p(i | \mathcal{X}, \mathcal{Y}') = p(i | \mathcal{X})$$

$$p(i, j, k, l, m, n, p, q | \text{circuit})$$

no signaling without interaction

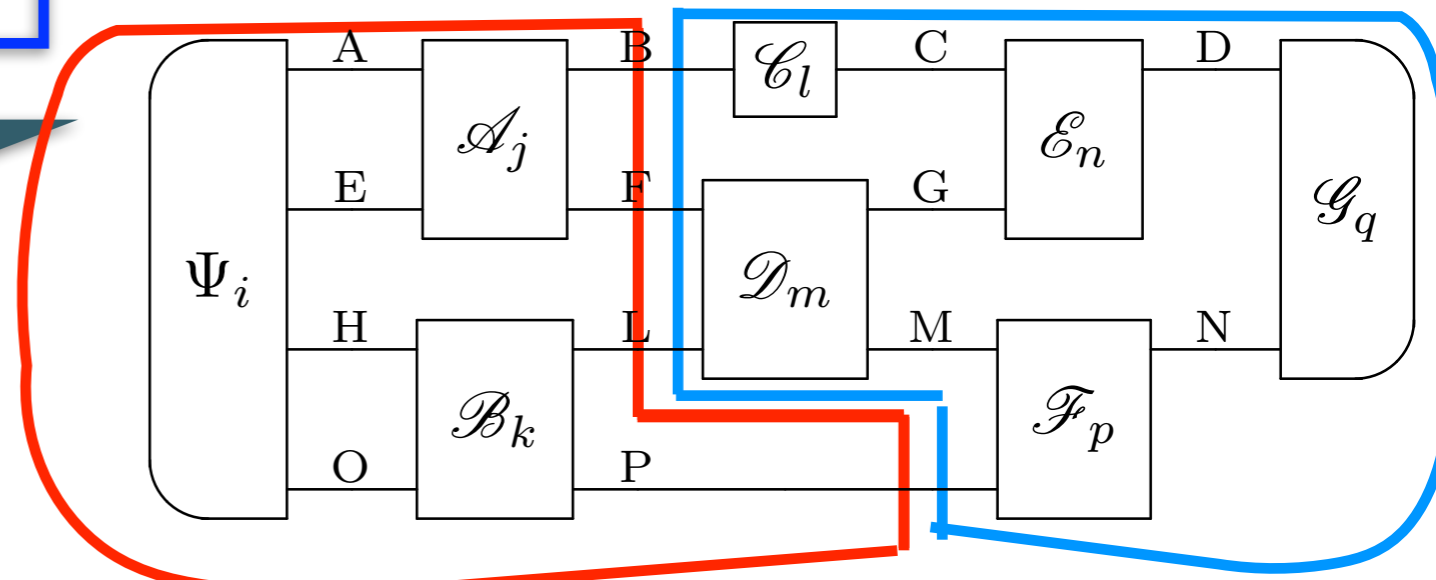
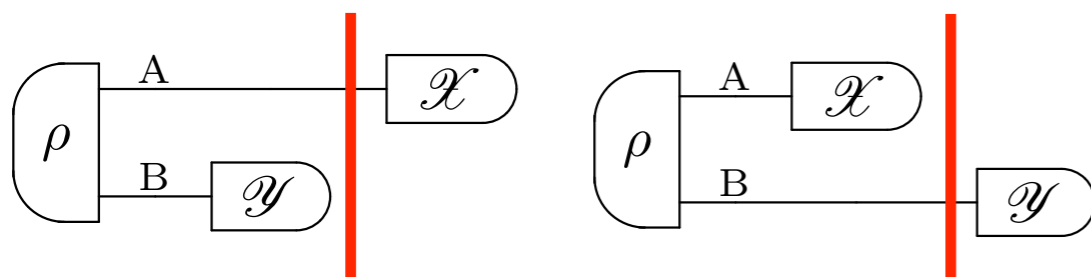

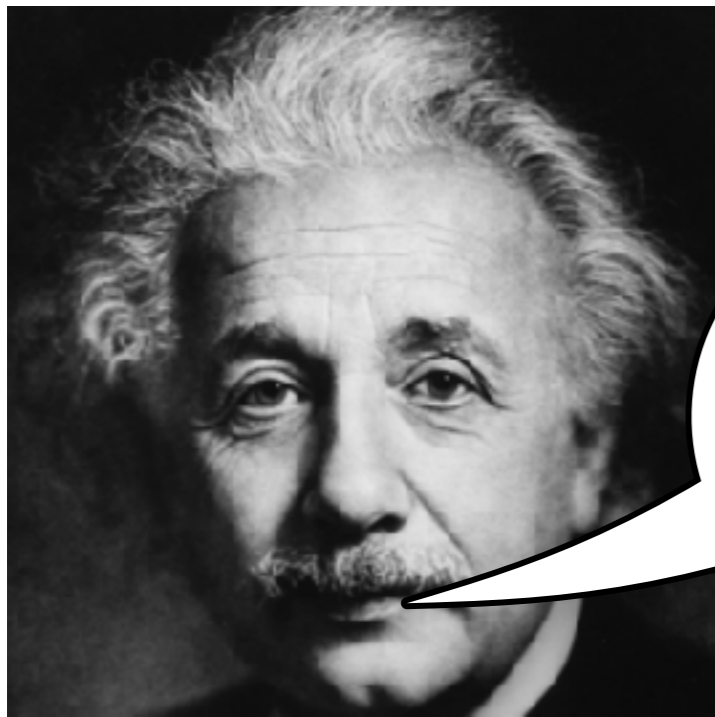

SPOOKY
ACTION AT
DISTANCE!

FLASH¹—A Superluminal Communicator Based Upon a New Kind of Quantum Measurement

Nick Herbert²

Received January 15, 1982

The FLASH communicator consists of an apparatus which can distinguish between plane unpolarized (PUP) and circularly unpolarized (CUP) light plus a simple EPR arrangement. FLASH exploits the peculiar properties of "measurements of the Third Kind." One purpose of this article is to focus attention on the operation of idealized laser gain tubes at the one-photon limit.

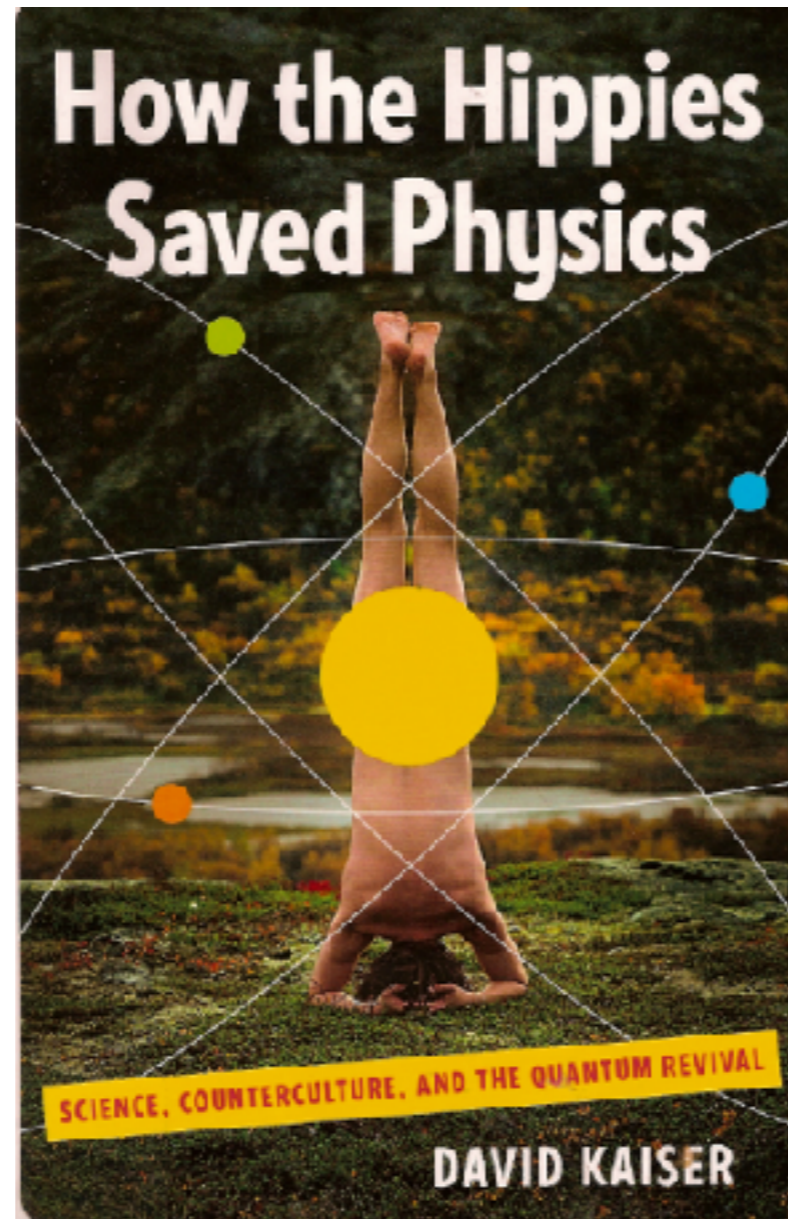

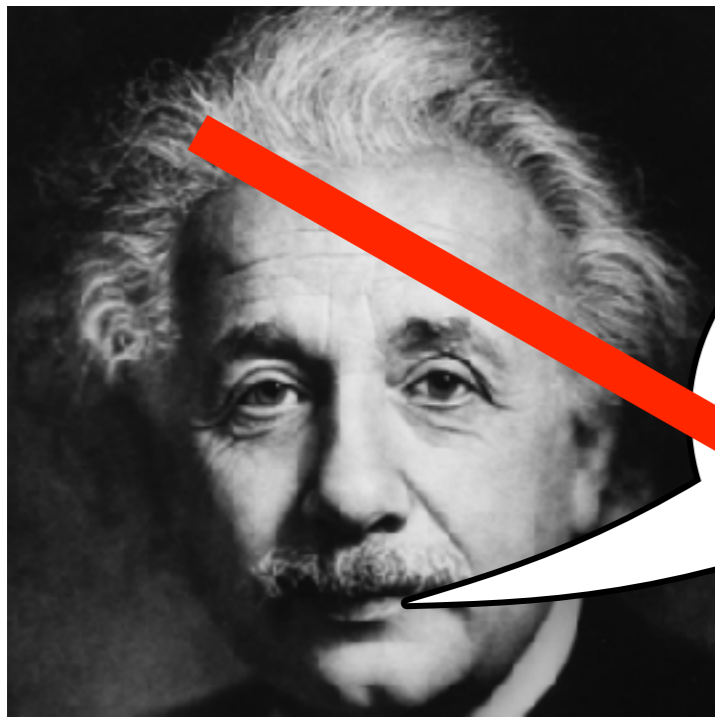

SPOOKY ACTION AT DISTANCE!

FLASH¹—A Superluminal Communicator Based Upon a New Kind of Quantum Measurement

Nick Herbert²

Received January 15, 1982

The FLASH communicator consists of an apparatus which can distinguish between plane unpolarized (PUP) and circularly unpolarized (CUP) light plus a simple EPR arrangement. FLASH exploits the peculiar properties of "measurements of the Third Kind." One purpose of this article is to focus attention on the operation of idealized laser gain tubes at the one-photon limit.



No signalling without interaction!

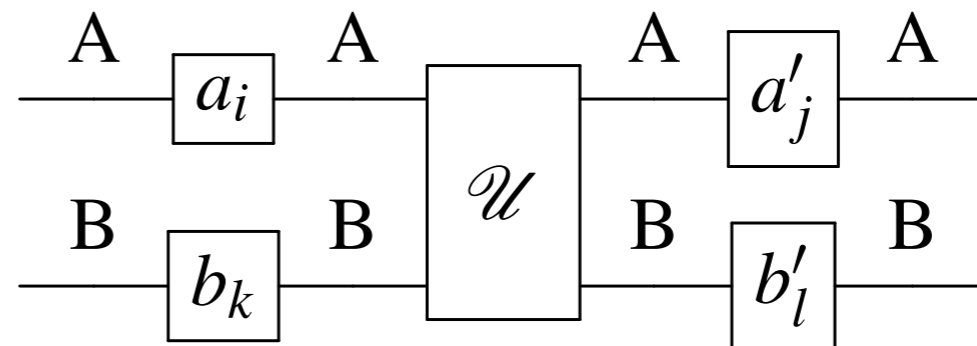
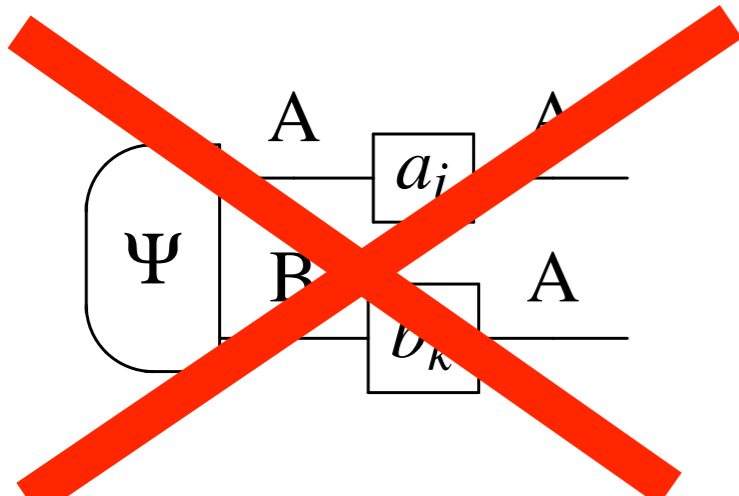

Fortuitous coincidence?

PEACEFUL COEXISTENCE
BETWEEN QUANTUM
MECHANICS AND RELATIVITY



NO!

A falsification experiment for causality

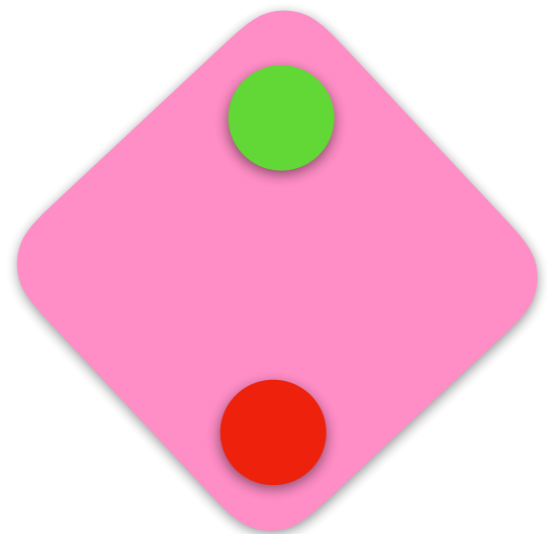

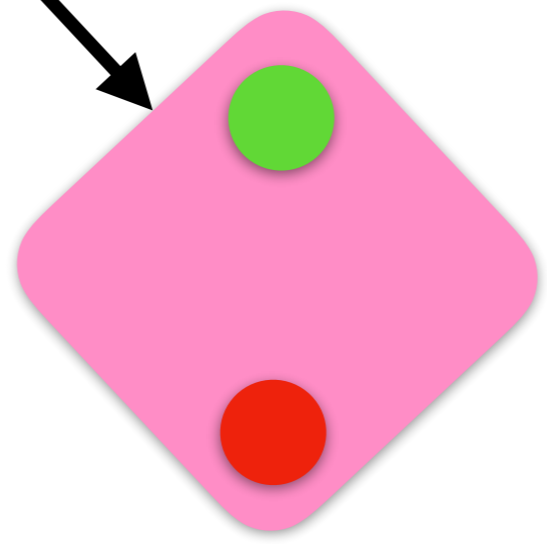
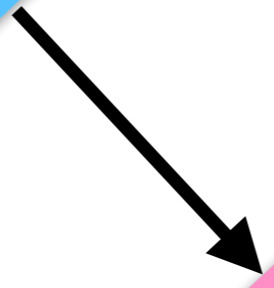
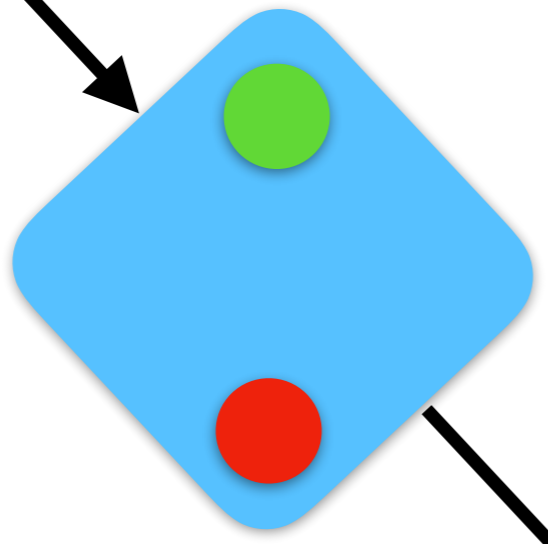
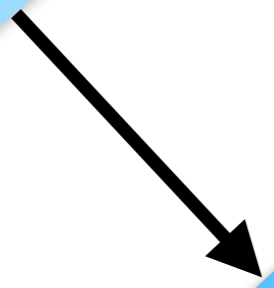
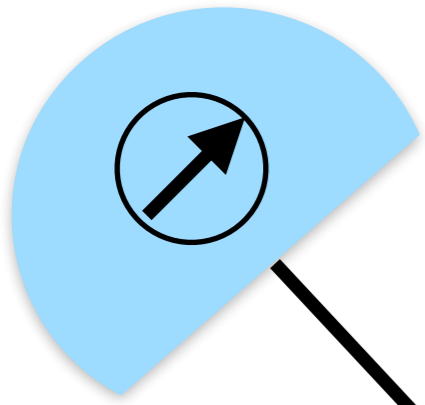

Experiment A

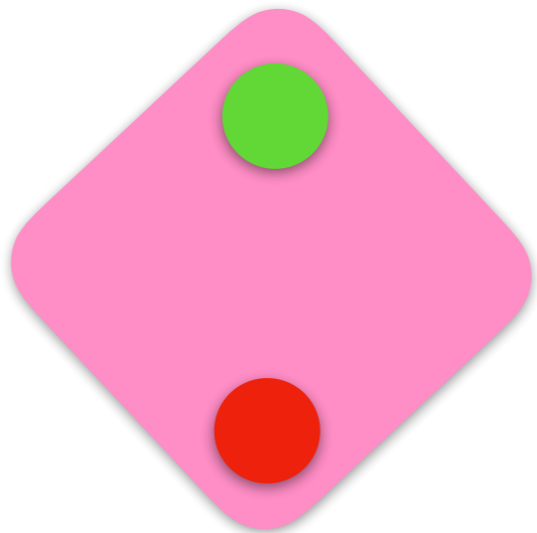

Experiment B

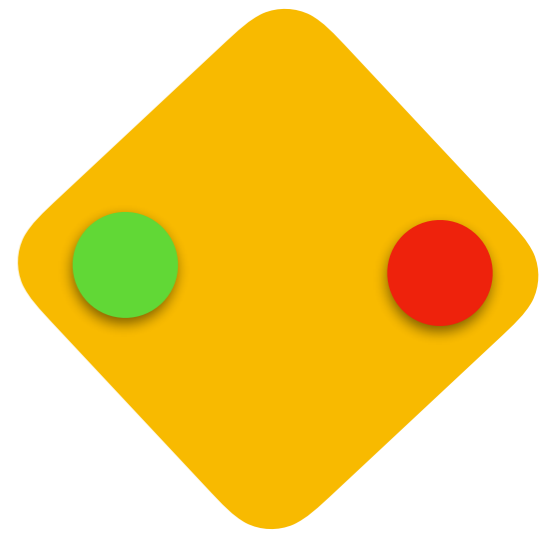

Experiment A

run 1

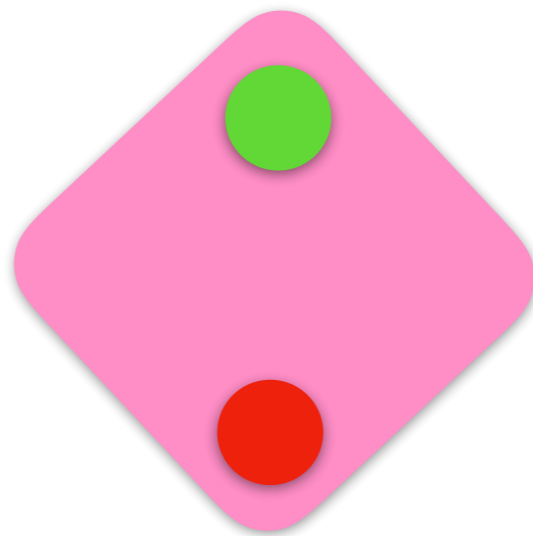

Experiment A

run 2

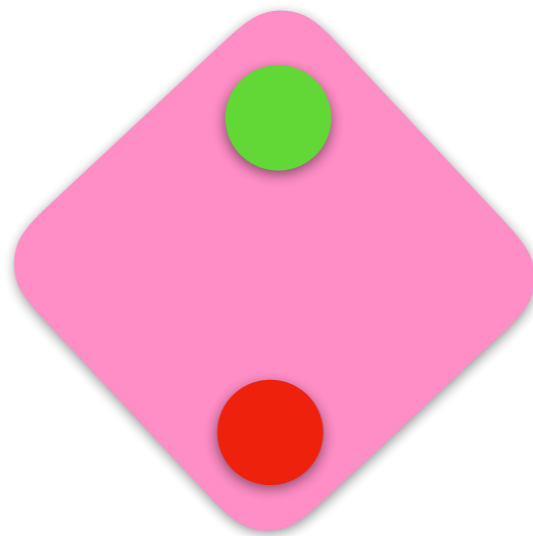

Experiment A

run 3

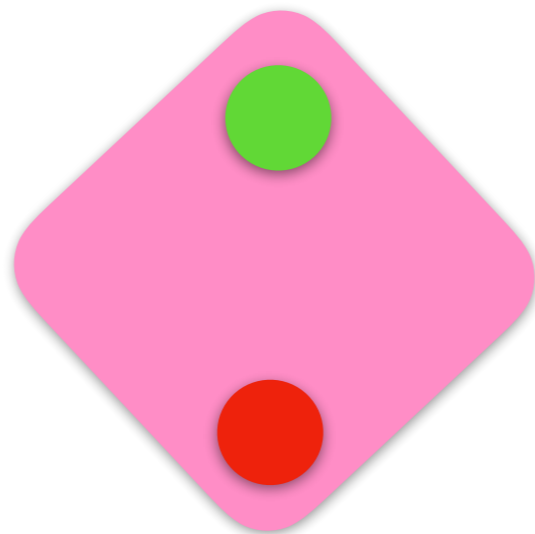

Experiment A

run 4

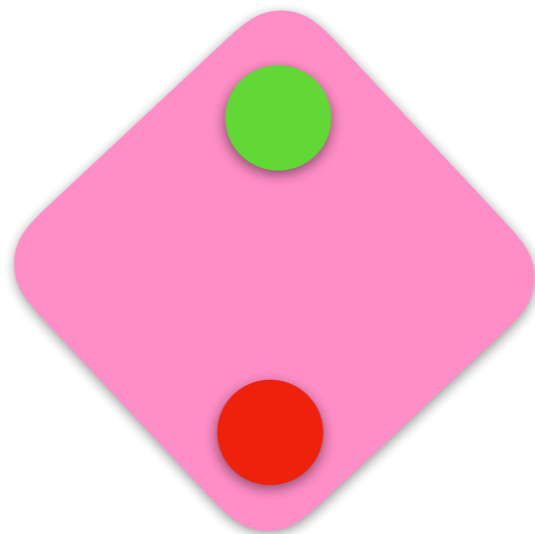

Experiment A

run 5

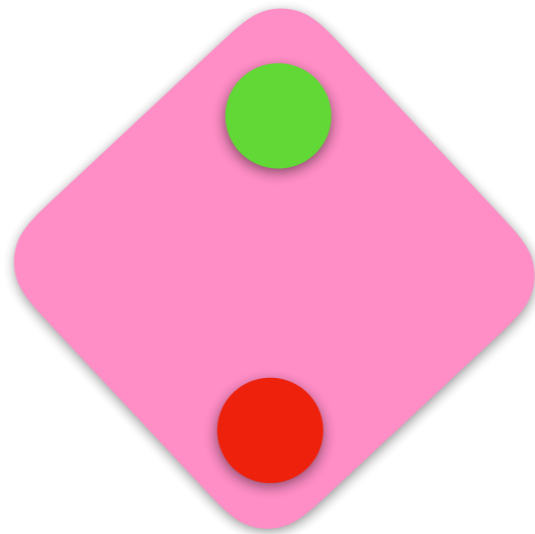

Experiment A

run 6

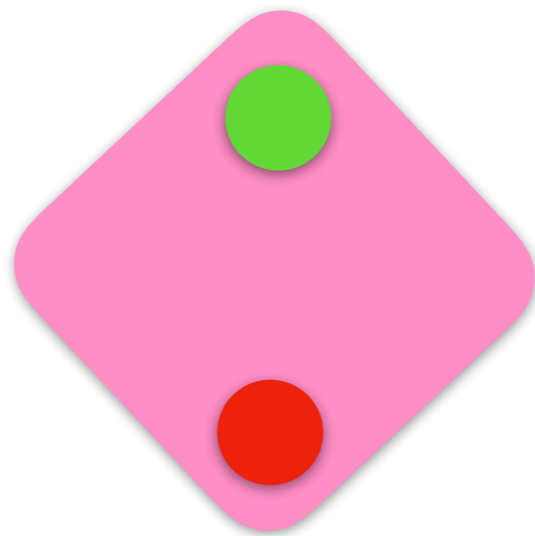

Experiment B

run 1

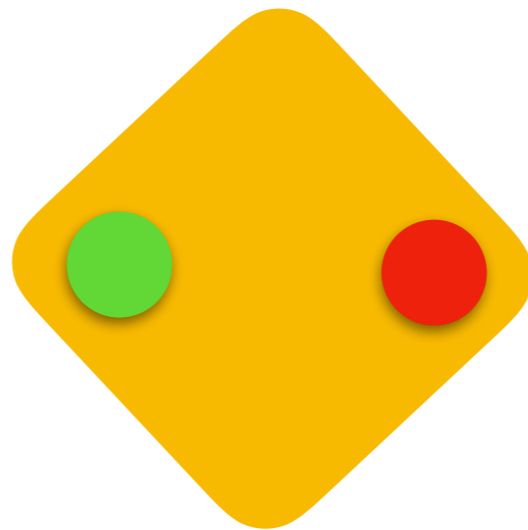

Experiment B

run 2

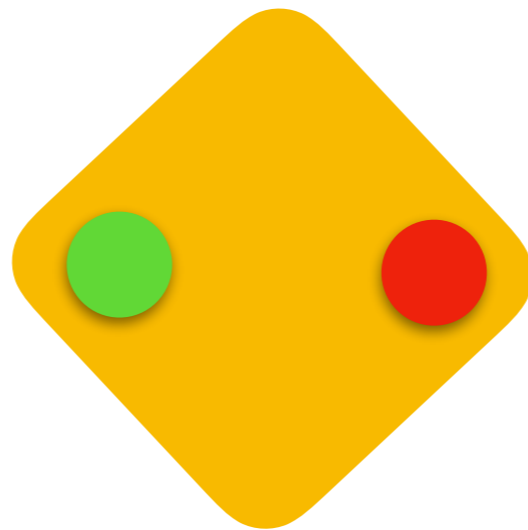

Experiment B

run 3

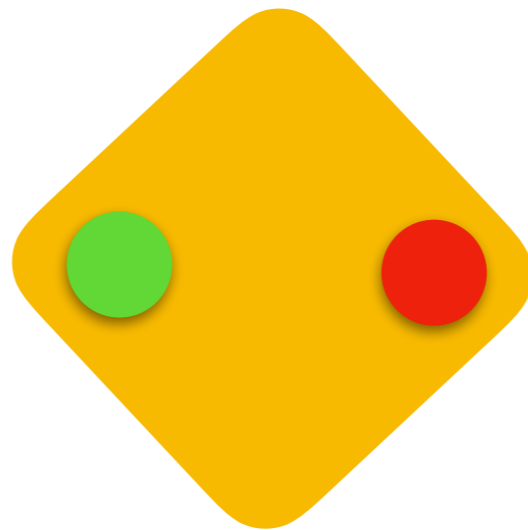

Experiment B

run 4

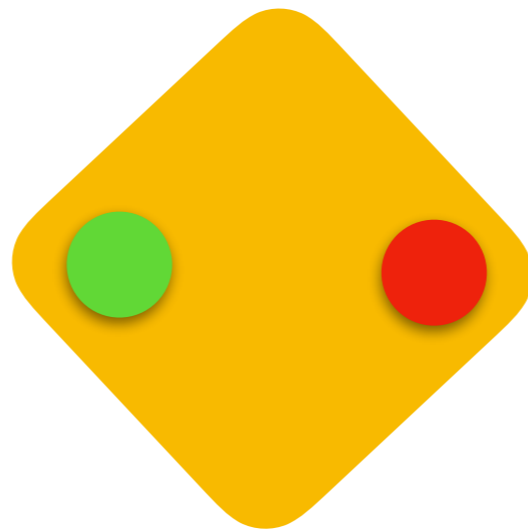

Experiment B

run 5

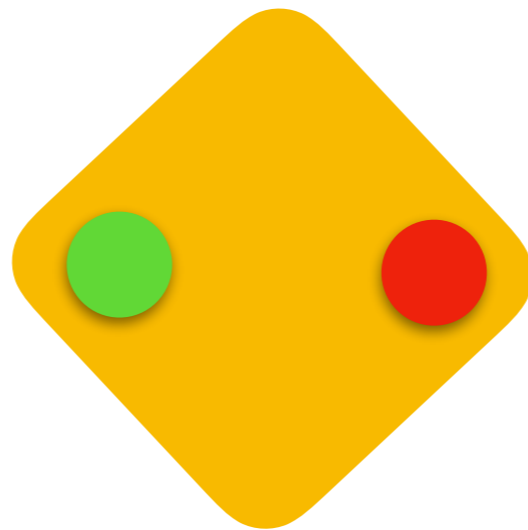

Experiment B

run 6

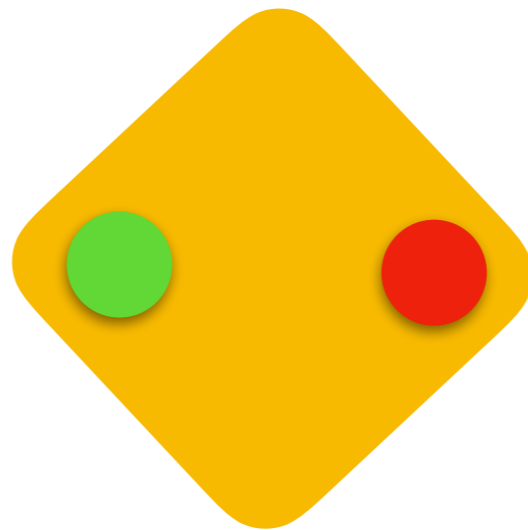

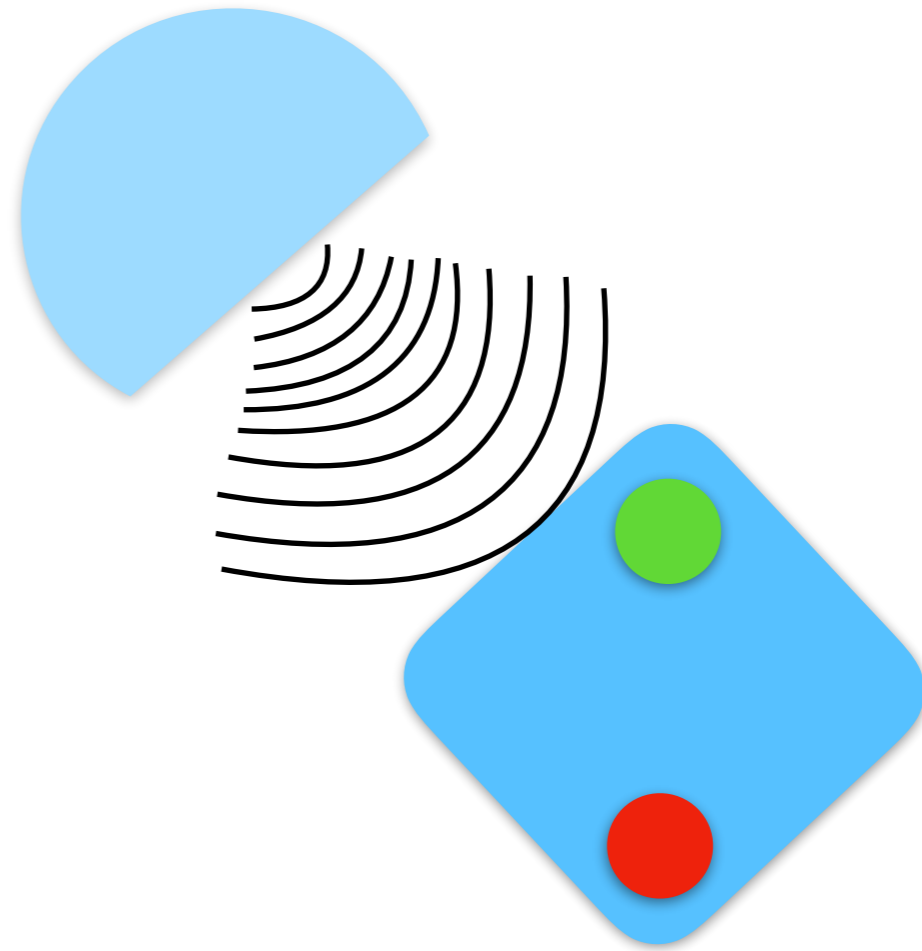
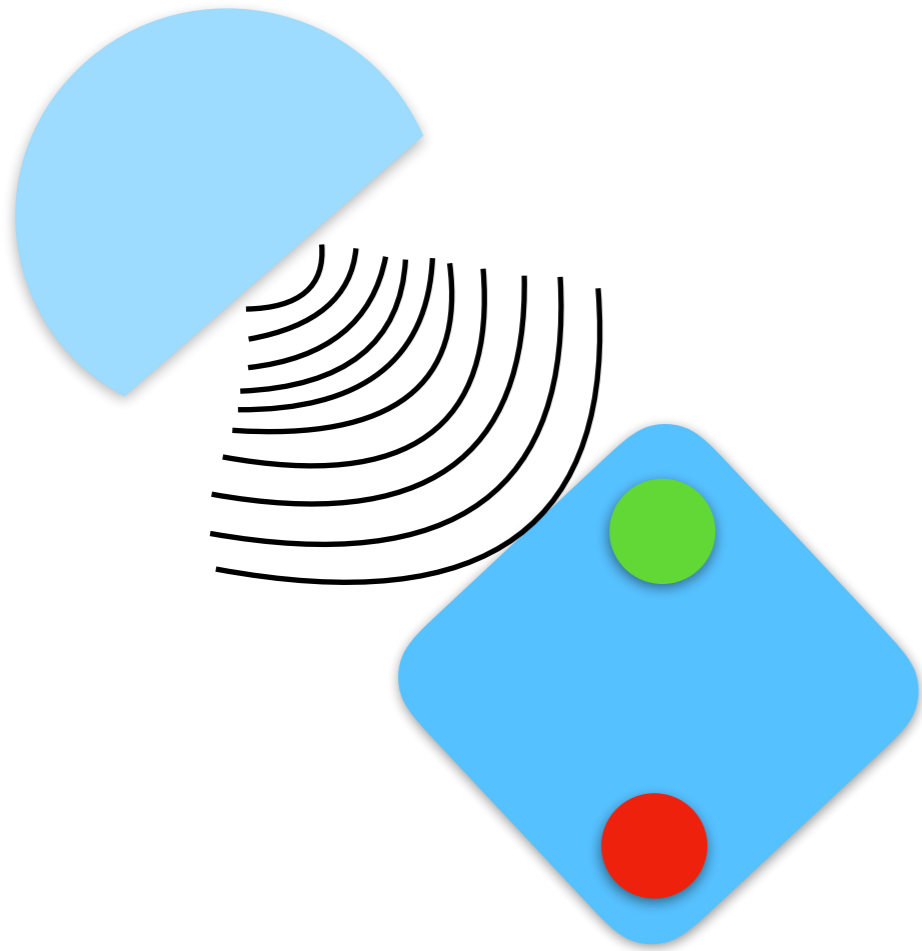

BIG

CRAINGH!

Principles for Quantum Theory

P1. Causality

causality sets a partial ordering between events

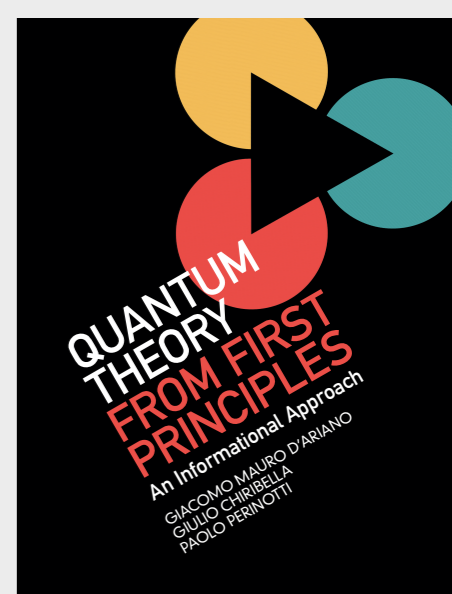

A theory (OPT) is causal iff the marginal probability of any test is independent on the choice of any test that does not precede it.

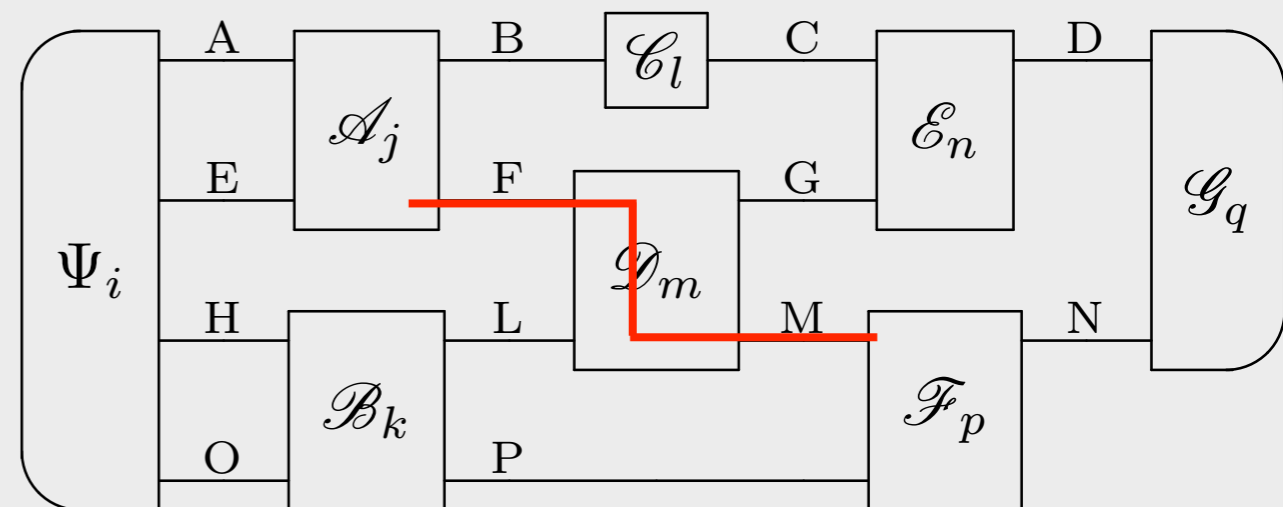

\mathcal{F} "follows" \mathcal{A}
 \mathcal{B} does not follow \mathcal{A}

Quantum causality is the same as Einstein's!

causality sets a partial ordering between events

partial ordering=cone

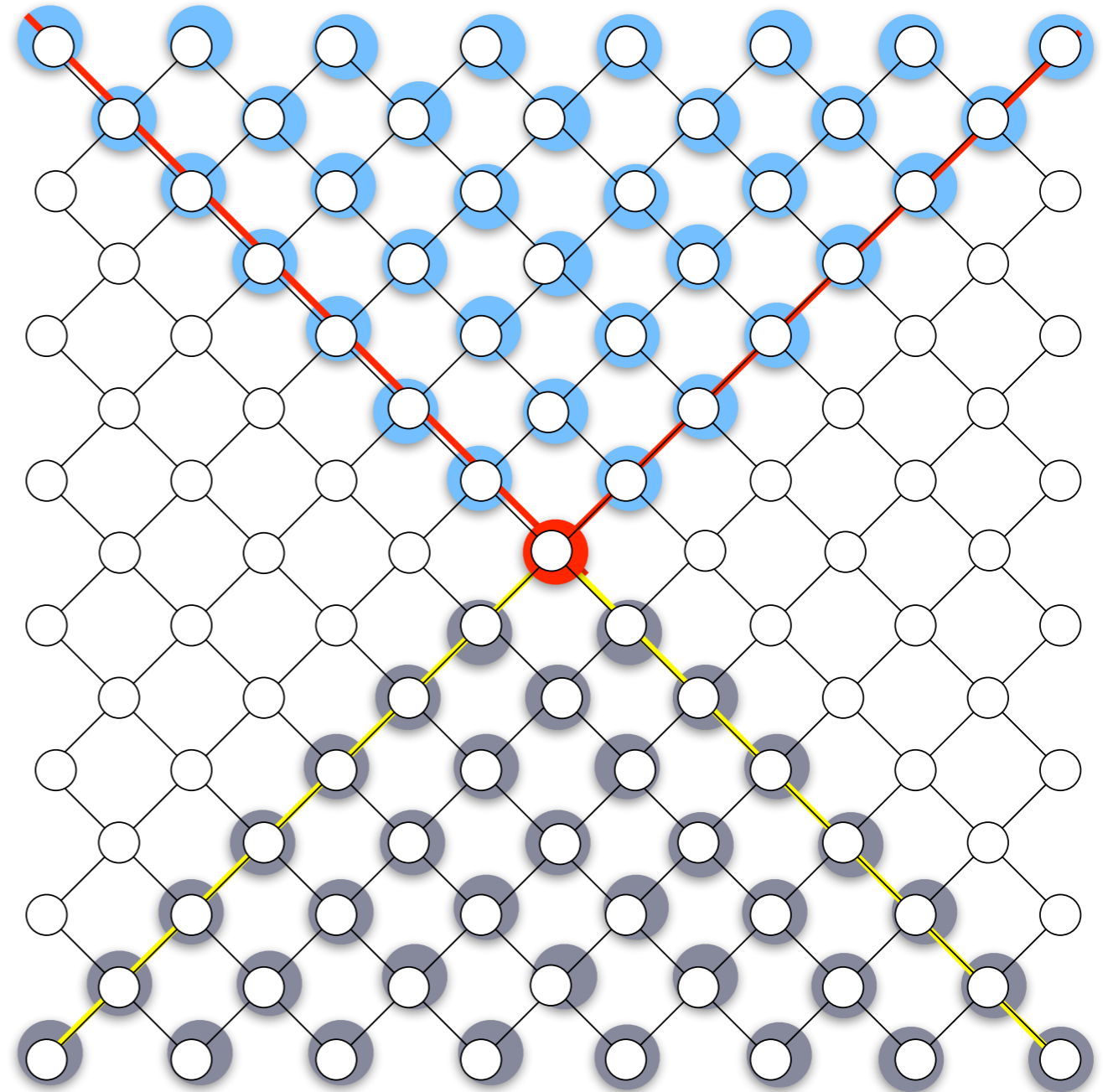
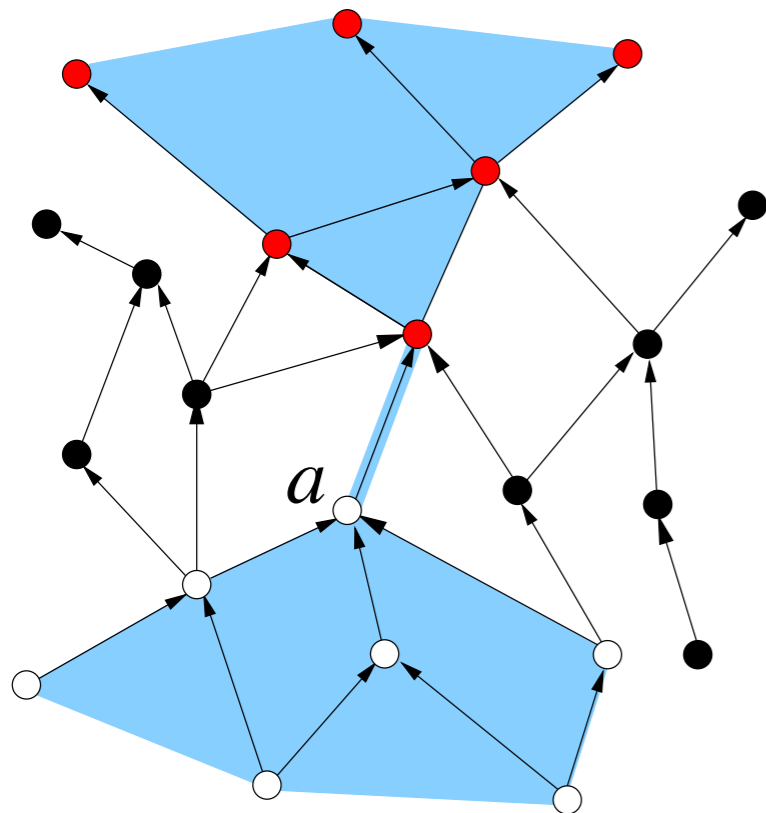

add homogeneity and isotropy

Quantum causality is the same of Einstein's!

causality sets a partial ordering between events

partial ordering = cone

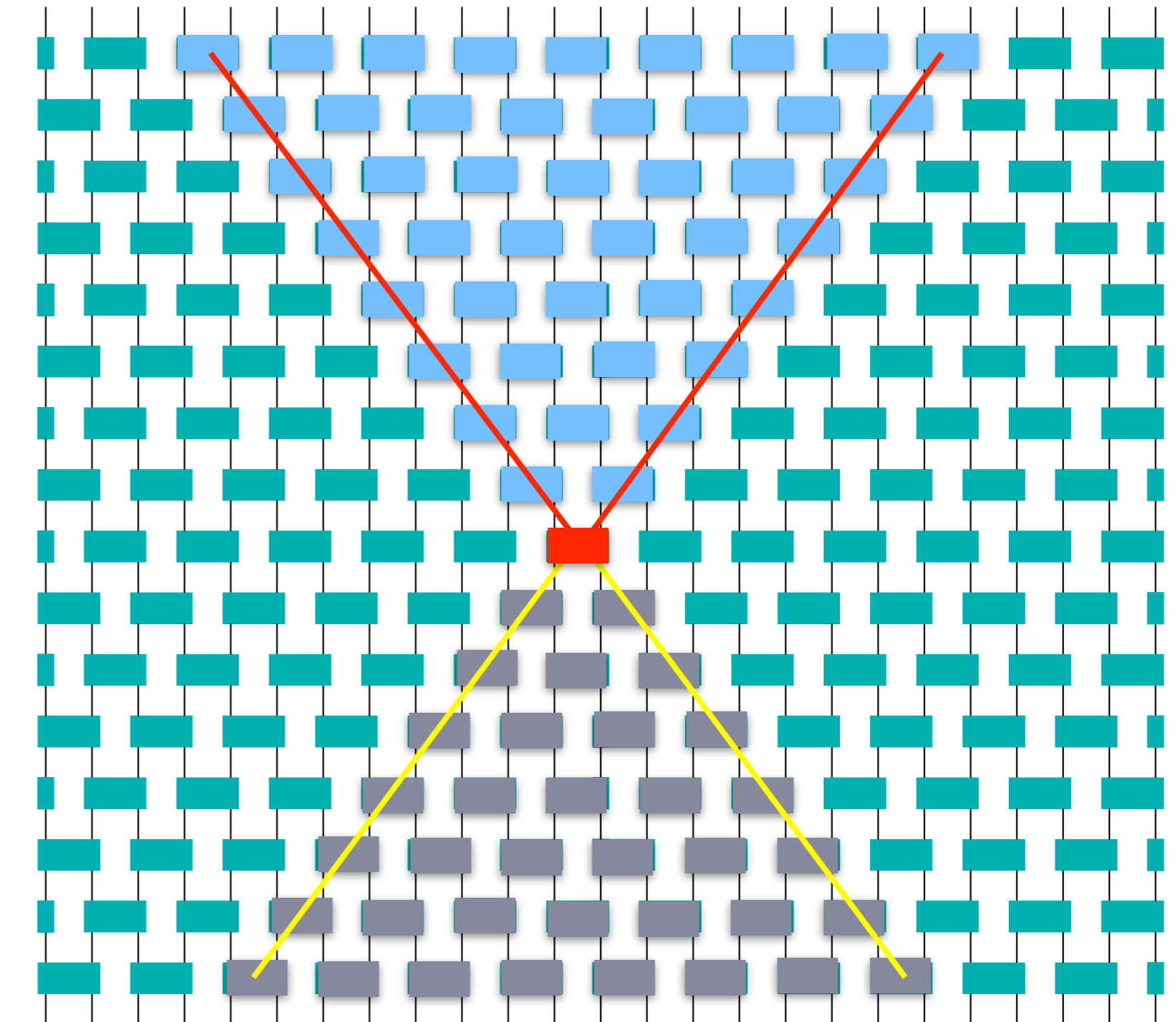
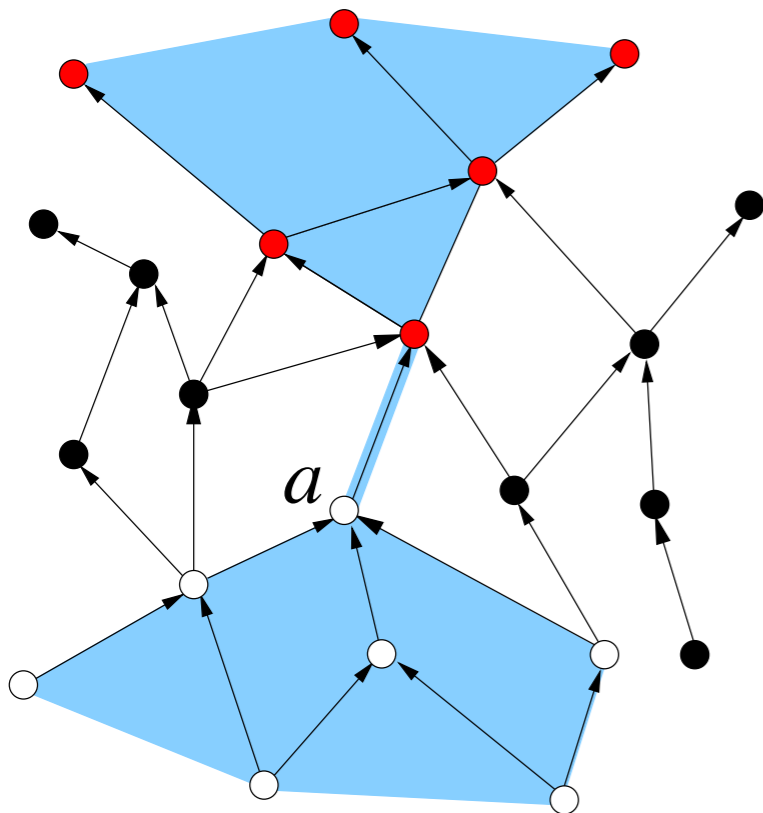

add quantumness! ➔ You get Lorentz!

Info-theoretical principles for Quantum Theory and Quantum Field Theory

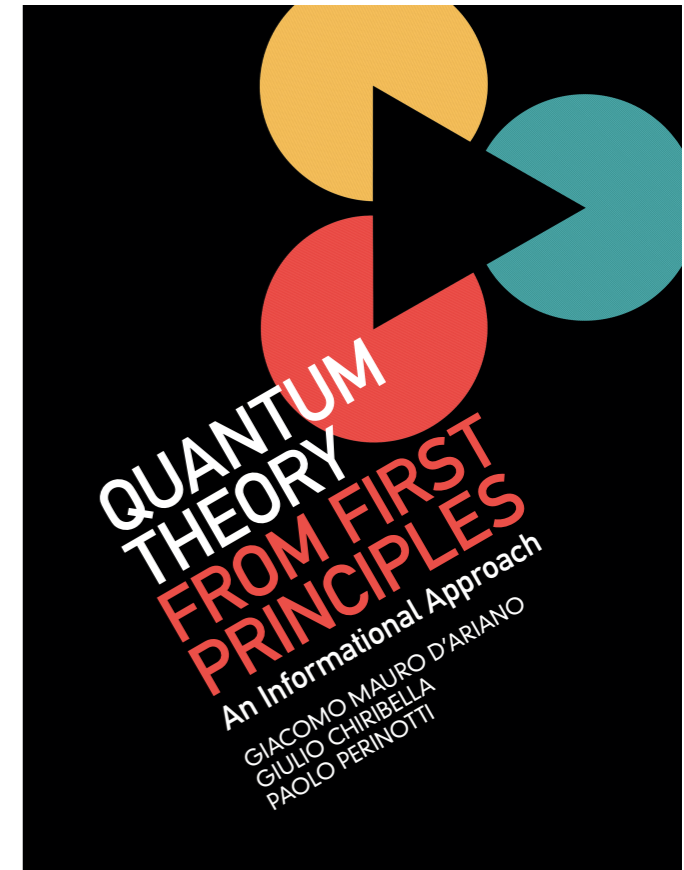
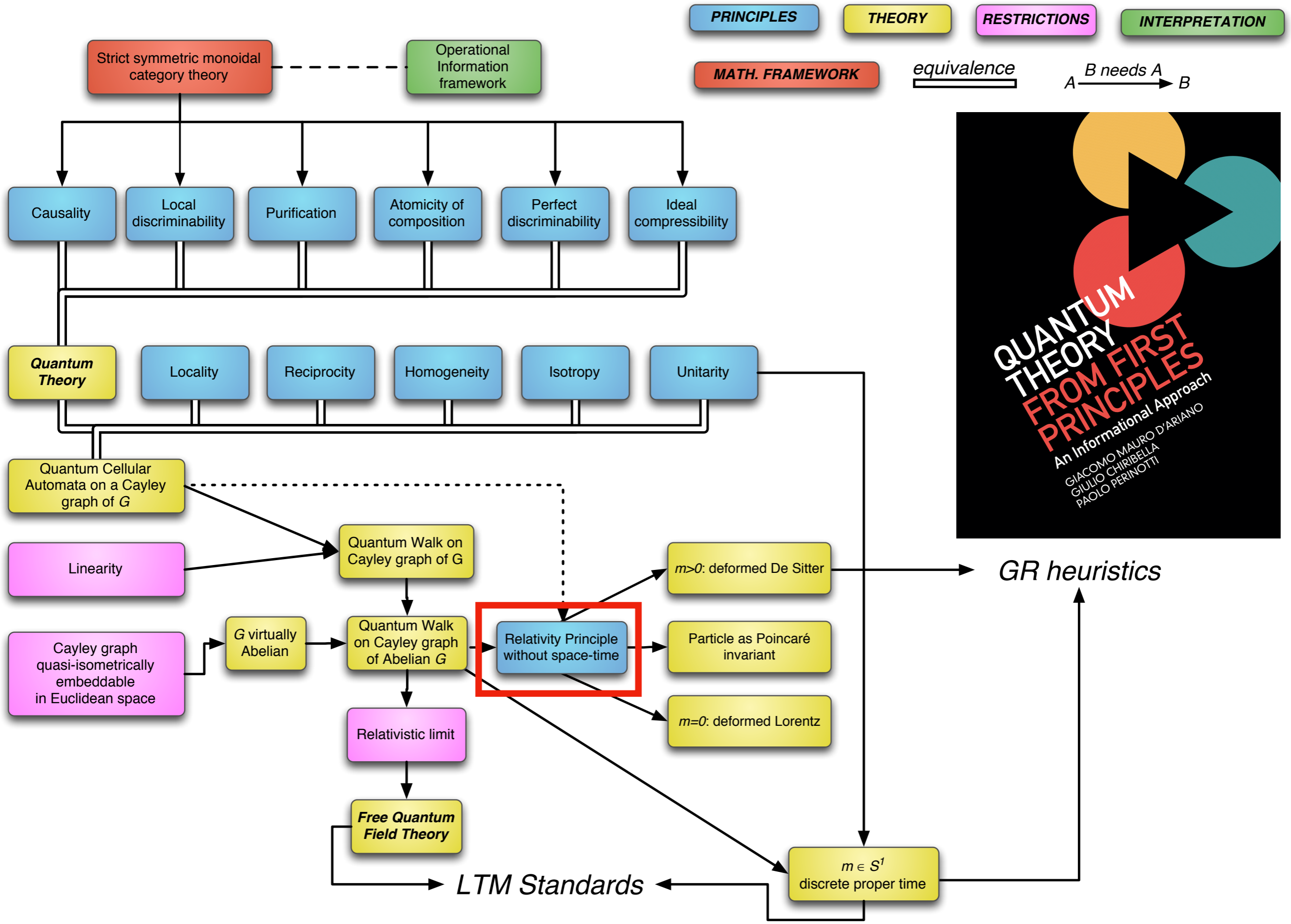

Deriving Lorentz transformations
from a numerable set of quantum systems
using no mechanics, no kinematics,
no space-time,

...

with a network of interactions that are
local, homogeneous, and isotropic

+linearity: a quantum walk

Quantum walk

$$A = \int_B \oplus d\mathbf{k} A_{\mathbf{k}}$$

$$A_{\mathbf{k}}\psi(\mathbf{k}, \omega) = e^{i\omega}\psi(\mathbf{k}, \omega)$$

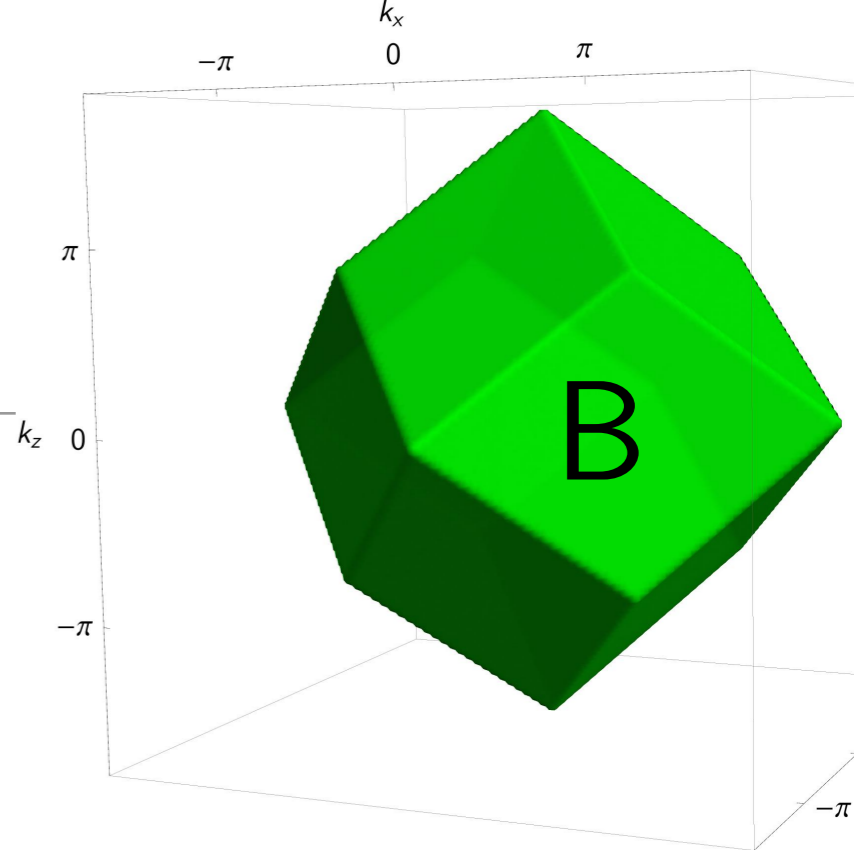

$$\dots \oplus \mathbb{C}^2 \oplus \mathbb{C}^2 \oplus \mathbb{C}^2 \oplus \mathbb{C}^2 \dots$$

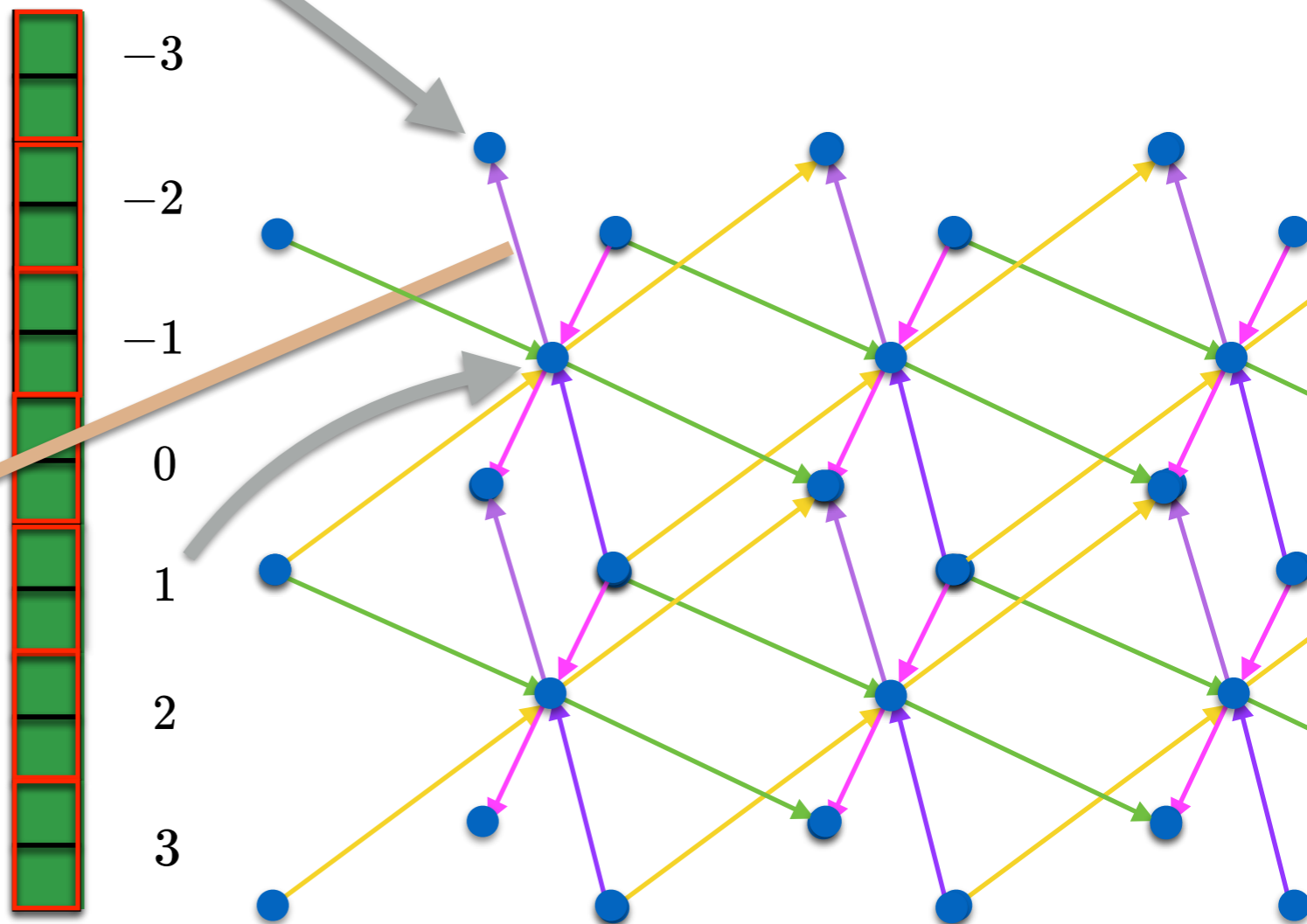
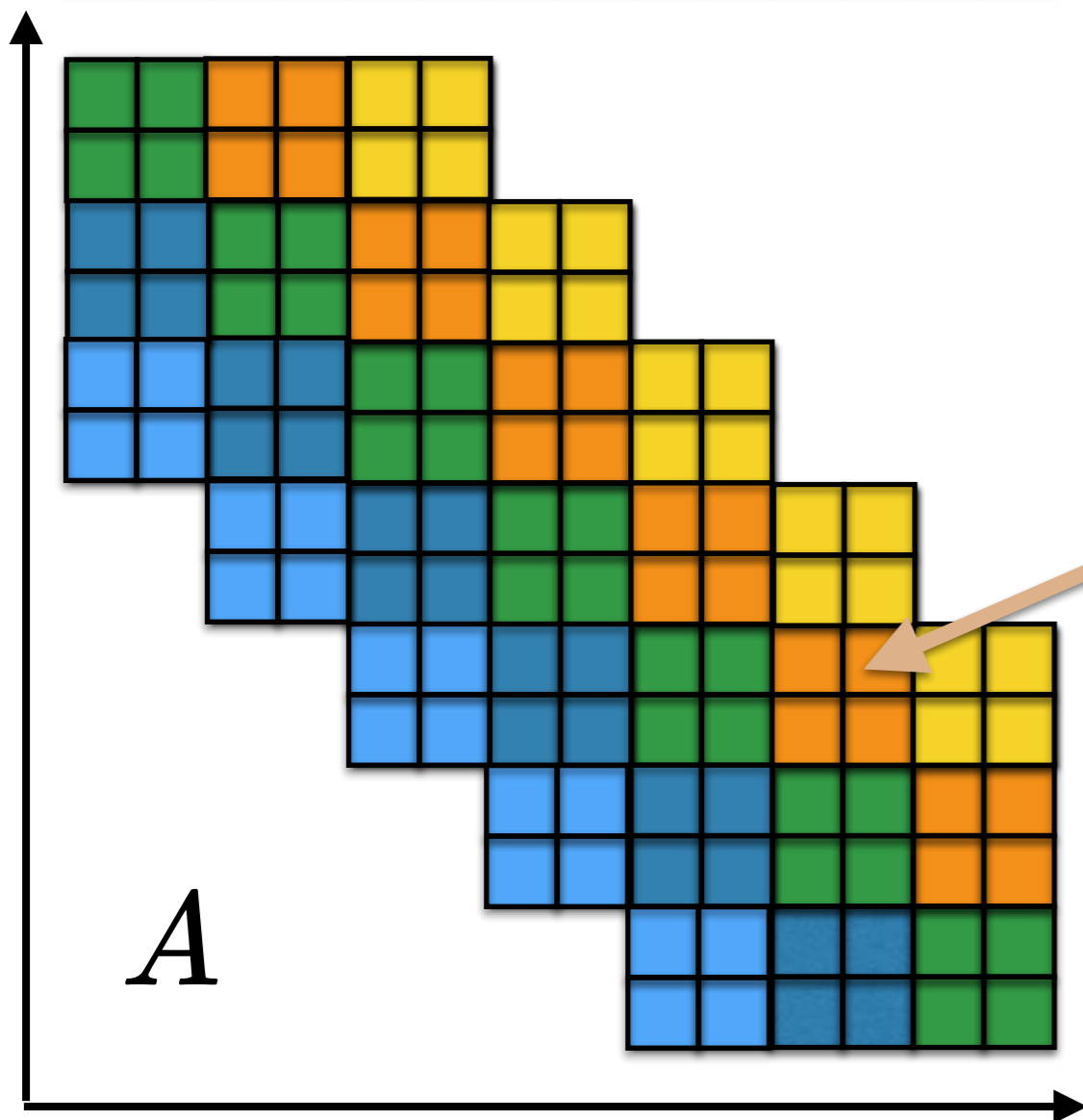
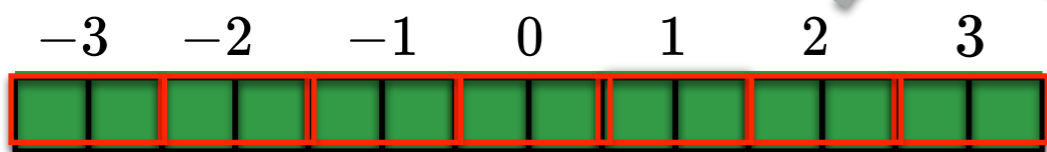

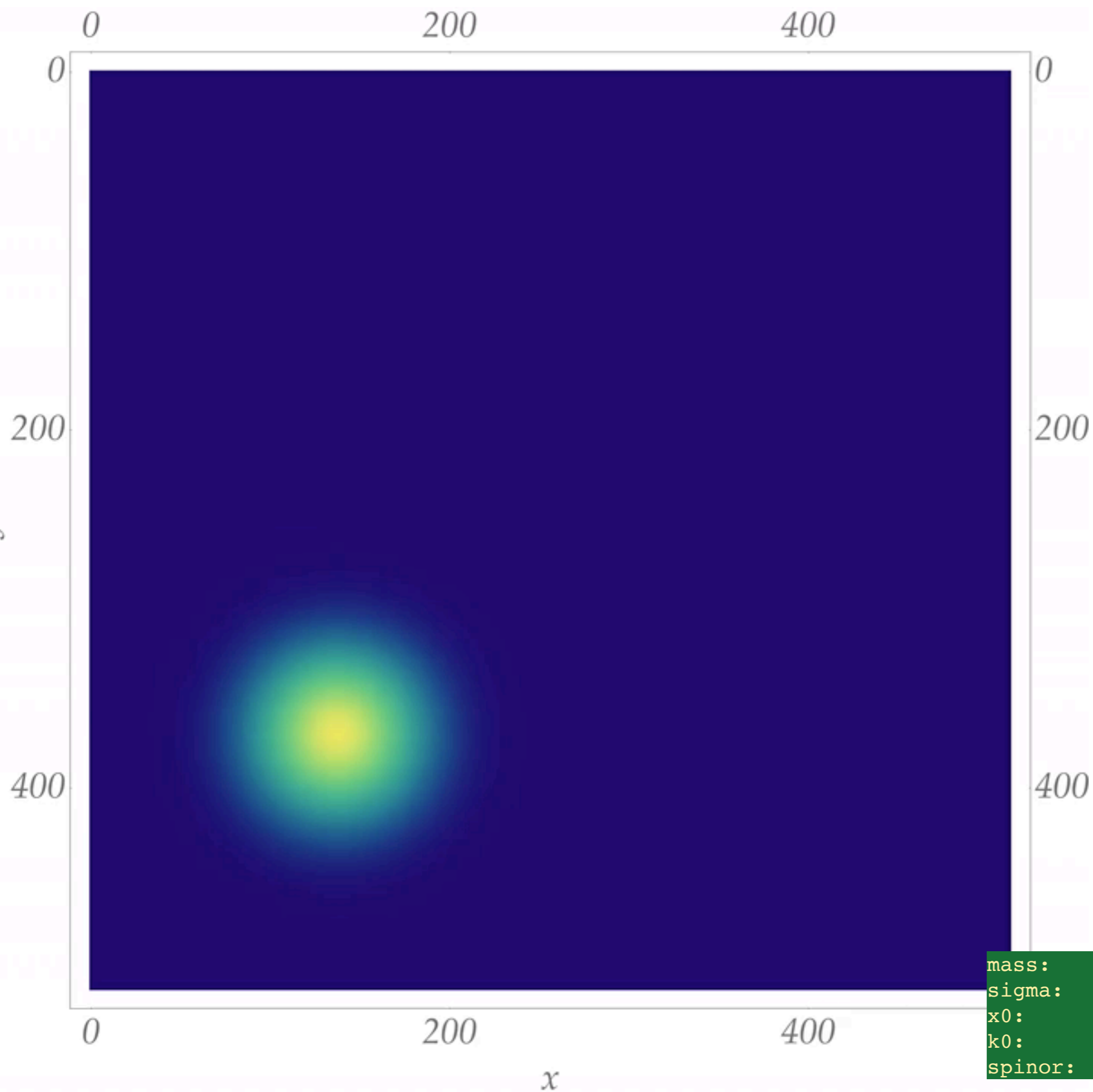

Dirac 3d

```
mass: 0.002  
sigma: 32  
x0: [140,140,140]  
k0: [0.05,0.05,0.05]  
spinor: ["Exp[I k0.#]",0,0,0]
```

Special Relativity from Quantum theory

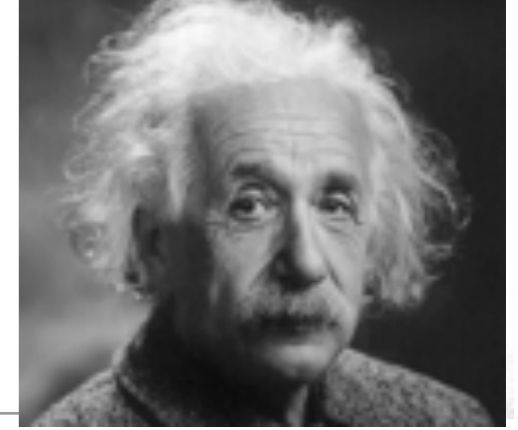

Relativity Principle: Invariance of the dynamical law with the inertial frame

Inertial frame: a reference frame where the Newton inertia law holds for a mechanically isolated system

**Maxwell
equations**

Einstein Special Relativity

Poincaré group: group of changes of inertial frame that leave the dynamical law invariant.

Special Relativity from Quantum theory

Relativity Principle: Invariance of the dynamical law with the inertial frame

 **Inertial frame:** a reference frame where energy and momentum are conserved for a mechanically *isolated* system.

Poincaré group: group of changes of inertial frame that leave the dynamical law invariant.

Special Relativity from Quantum theory

Relativity Principle: Invariance of the dynamical law with the inertial frame

 **Inertial frame:** Representation of the dynamical law for *given values* of the constants of motion for an *isolated* system.

Inertial representation of the Dynamical law: expressed in terms of the values of the *constants of motion*.

Poincaré group \rightarrow group of inertial symmetries of the dynamics:
group of changes of inertial frame that leave the dynamical law invariant.

good for any dynamical system!

Special Relativity from Quantum theory

Relativity Principle: Invariance of the dynamical law with the inertial frame

Inertial frame: Representation of the physical law in terms of eigenspaces of the constants of the dynamics $k := (\omega, \mathbf{k})$

Inertial representation of the Dynamical law: eigenvalue equation

$$A_{\mathbf{k}}\psi(\mathbf{k}, \omega) = e^{i\omega} \psi(\mathbf{k}, \omega) \quad \omega \rightarrow \omega(\mathbf{k})$$

Group of inertial symmetries of the dynamics: group of changes of representations in terms of eigenspaces of the constants of dynamics that leave the eigenvalue equation invariant.

Planck-scale effects: Lorentz covariance distortion

Transformations that leave the dispersion relation invariant

$$\omega^{(\pm)}(\mathbf{k})$$

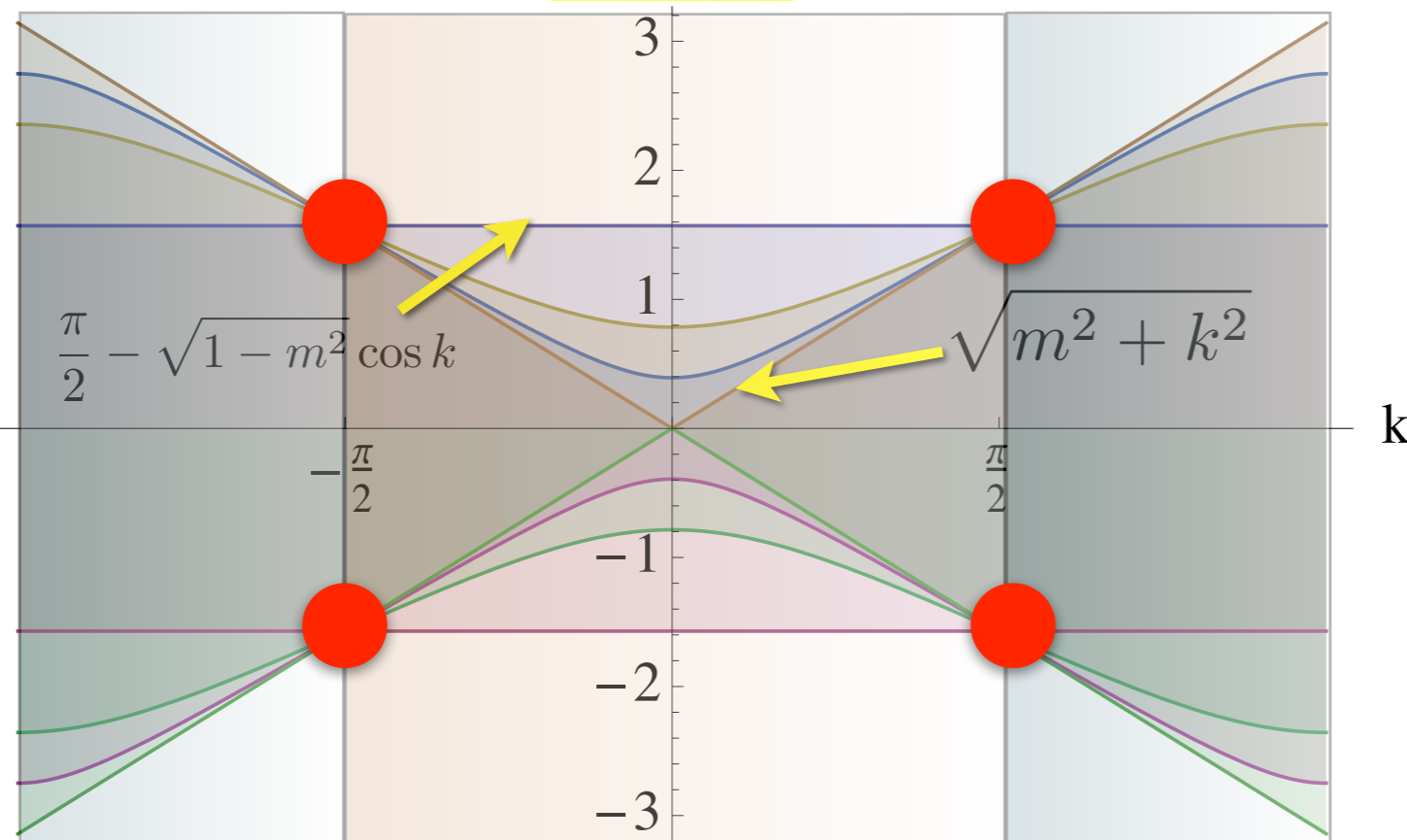

$$\omega_E(k) := \pm \cos^{-1}(\sqrt{1 - m^2} \cos k)$$

$$L_\beta^D := \mathcal{D}^{-1} \circ L_\beta \circ \mathcal{D}$$

$$L_\beta : (\omega, k) \mapsto (\omega', k') = \gamma(\omega - \beta k, k - \beta\omega)$$

$$\mathcal{D}(\omega, k) := (\sin \omega / \cos k, \tan k) \quad \gamma := (1 - \beta^2)^{-1/2}$$

Special Relativity from Quantum theory

$m=0$: Weyl Quantum Walk

Group of inertial symmetries of the dynamics: nonlinear Lorentz (Poincaré).

Usual Lorentz recovered for $k \ll 1$

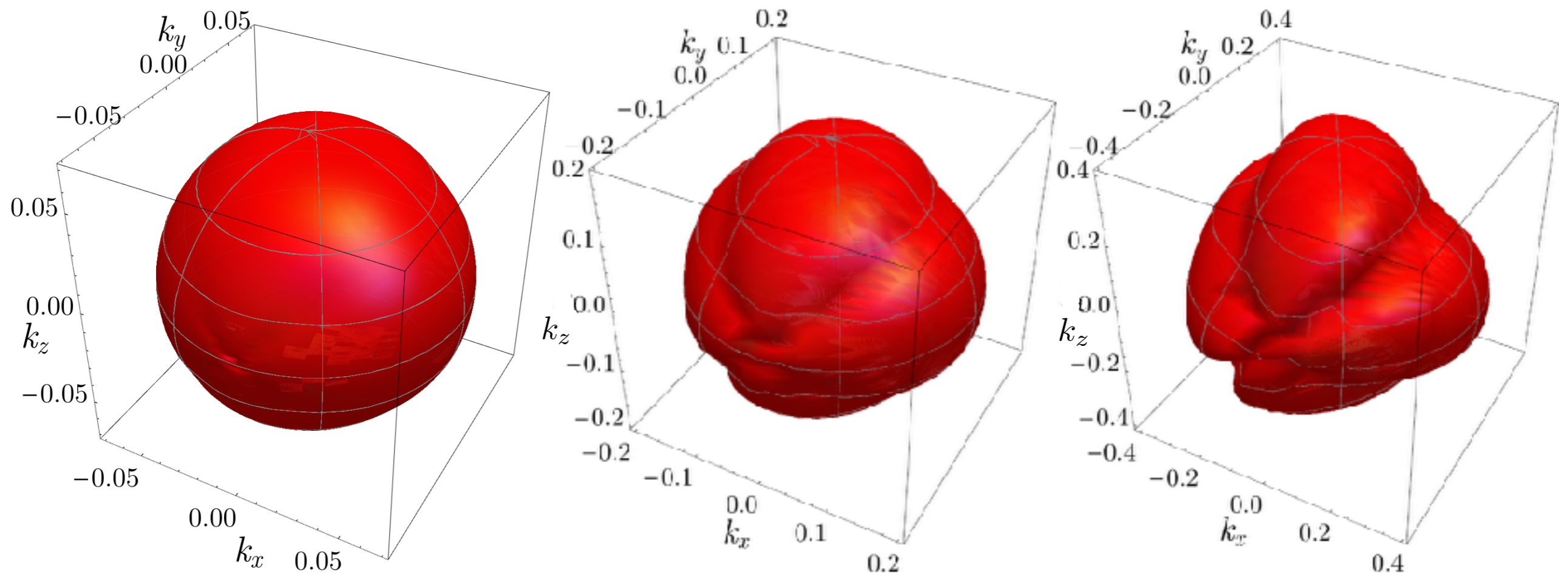

Special Relativity from Quantum theory

$m=0$: Weyl Quantum Walk

Group of inertial symmetries of the dynamics: nonlinear Lorentz (Poincaré).

Usual Lorentz recovered for $k \ll 1$

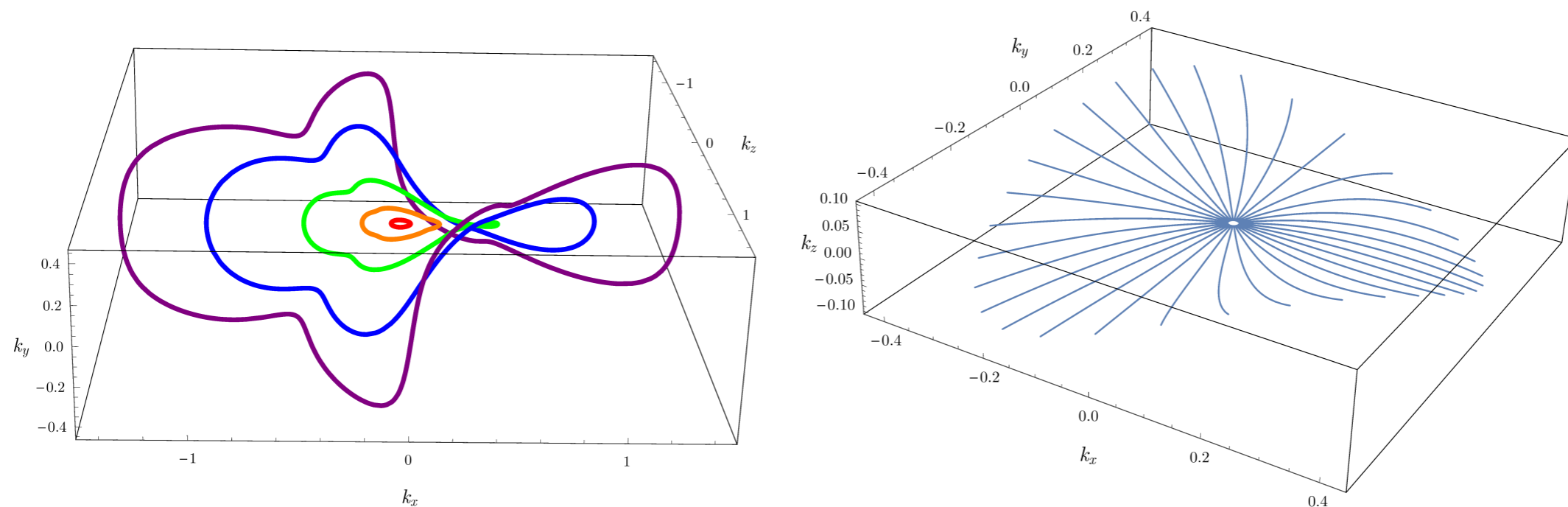

FIG. 2: The distortion effects of the Lorentz group for the discrete Planck-scale theory represented by the quantum walk in Eq. (6). Left figure: the orbit of the wavevectors $\mathbf{k} = (k_x, 0, 0)$, with $k_x \in \{.05, .2, .5, 1, 1.7\}$ under the rotation around the z axis. Right figure: the orbit of wavevectors with $|\mathbf{k}| = 0.01$ for various directions in the (k_x, k_y) plane under the boosts with β parallel to \mathbf{k} and $|\beta| \in [0, \tanh 4]$.

Special Relativity from Quantum theory

$m > 0$: Dirac Quantum Walk

Group of inertial symmetries of the dynamics: nonlinear De-Sitter
The rest mass m becomes a variable

Linear De Sitter recovered for $k \ll 1$
Linear Lorentz recovered for $k, m \ll 1$

A. Bisio, G. M. D'Ariano, P. Perinotti, PRA **94** 042120 (2016)

Classically

rest-mass m and proper time τ
canonically conjugated variables

$$H(q_\alpha, p_\alpha, \tau, m) = \sum_{\alpha} p_\alpha \dot{q}_\alpha + c^2 m \dot{\tau} - L$$

Quantum

m, τ Fourier-conjugated

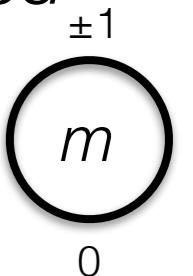
$m \in S^1$ (from unitarity) 

$$m \in S^1 \implies \tau \in \mathbb{Z}$$

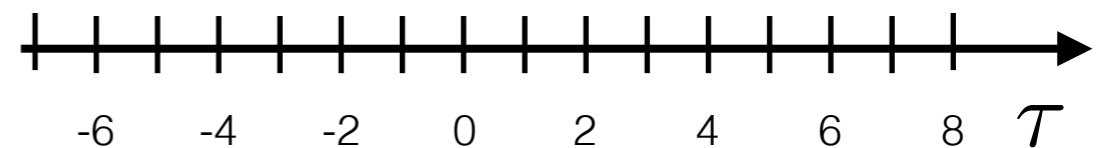

Particle notion without mechanics

Particle: irrep. of the group of symmetries of the dynamics.

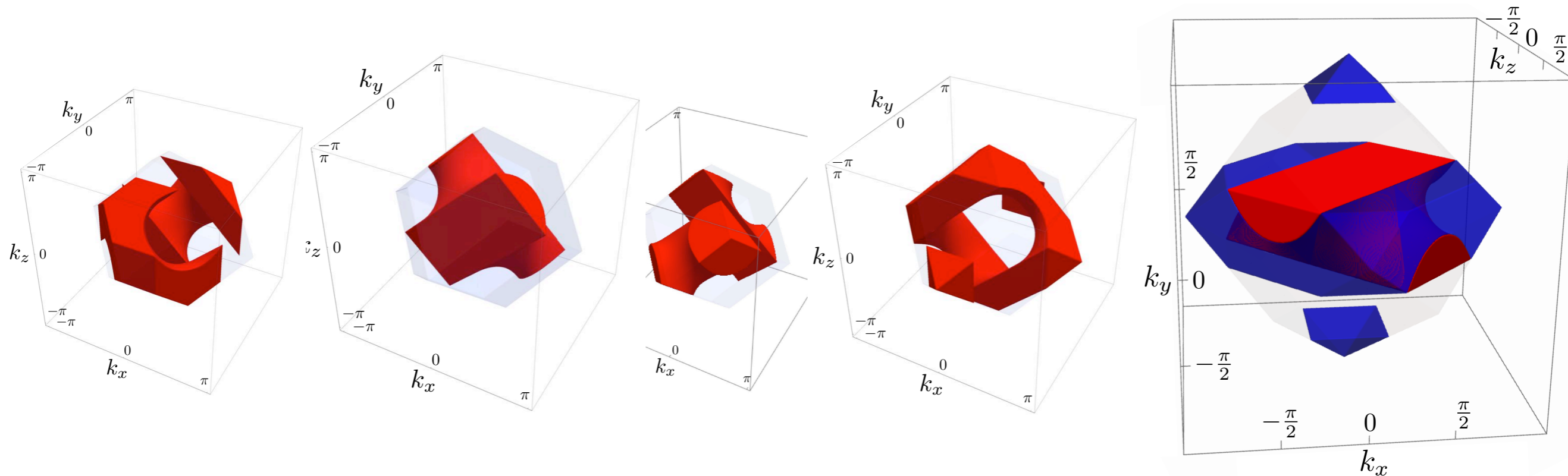

The Brillouin zone separates into four Poincaré-invariant regions diffeomorphic to balls, corresponding to four different particles.

Fermion doubling: Additional symmetries from topology of interactions give rise to new particles.

G. Chiribella, G. M. D'Ariano, P. Perinotti, *Informational derivation of Quantum Theory*, Phys. Rev A **84** 012311 (2011)

G. M. D'Ariano, P. Perinotti, *The Dirac Equation from Principles of Information processing*, Phys. Rev. A **90** 062106 (2014)

A. Bisio, G. M. D'Ariano, P. Perinotti, *Quantum Cellular Automaton Theory of Light*, Ann. Phys. **368** 177 (2016)

A. Bisio, G. M. D'Ariano, P. Perinotti, *Special relativity in a discrete quantum universe*, Phys. Rev. A **94**, 04a2120 (2016)

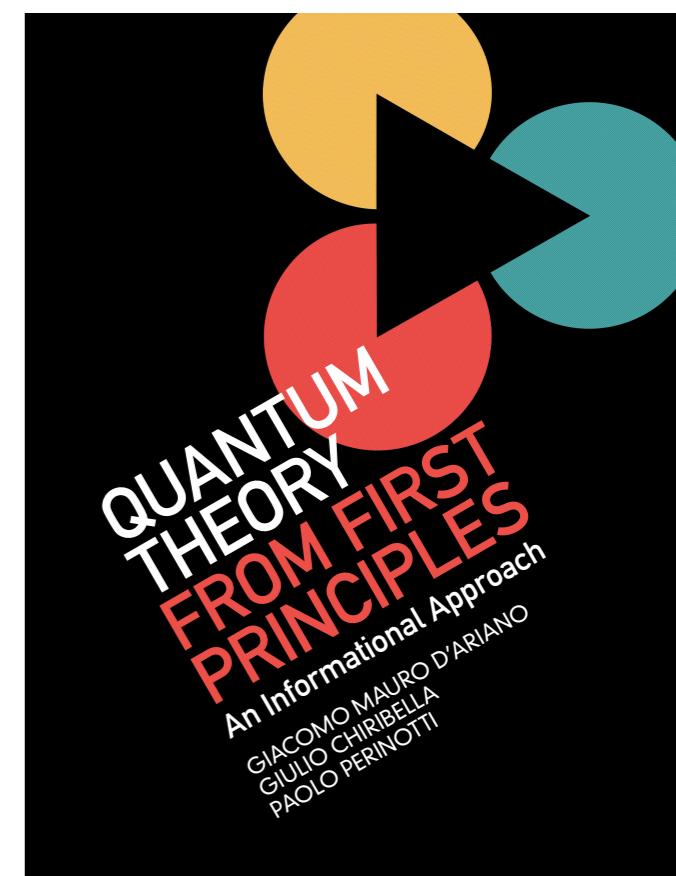

Paolo Perinotti



Alessandro Bisio



Alessandro Tosini

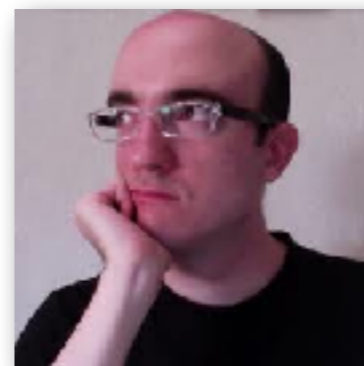

Nicola Mosco



Marco Erba



Giulio Chiribella

This is more or less what I wanted to say

Thank you for your attention!

Follow **project on Researchgate**: *The algorithmic paradigm: deriving the whole physics from information-theoretical principles.*

REVIEW

G. M. D'Ariano, *Physics without Physics*, Int. J. Theor. Phys. **128** 56 (2017),
[in memoriam of D. Finkelstein]

